



**VORTICE**

vortice.com



RESIDENTIAL VENTILATION 

## CATALOGUE

Heat recovery and continuous mechanical ventilation system

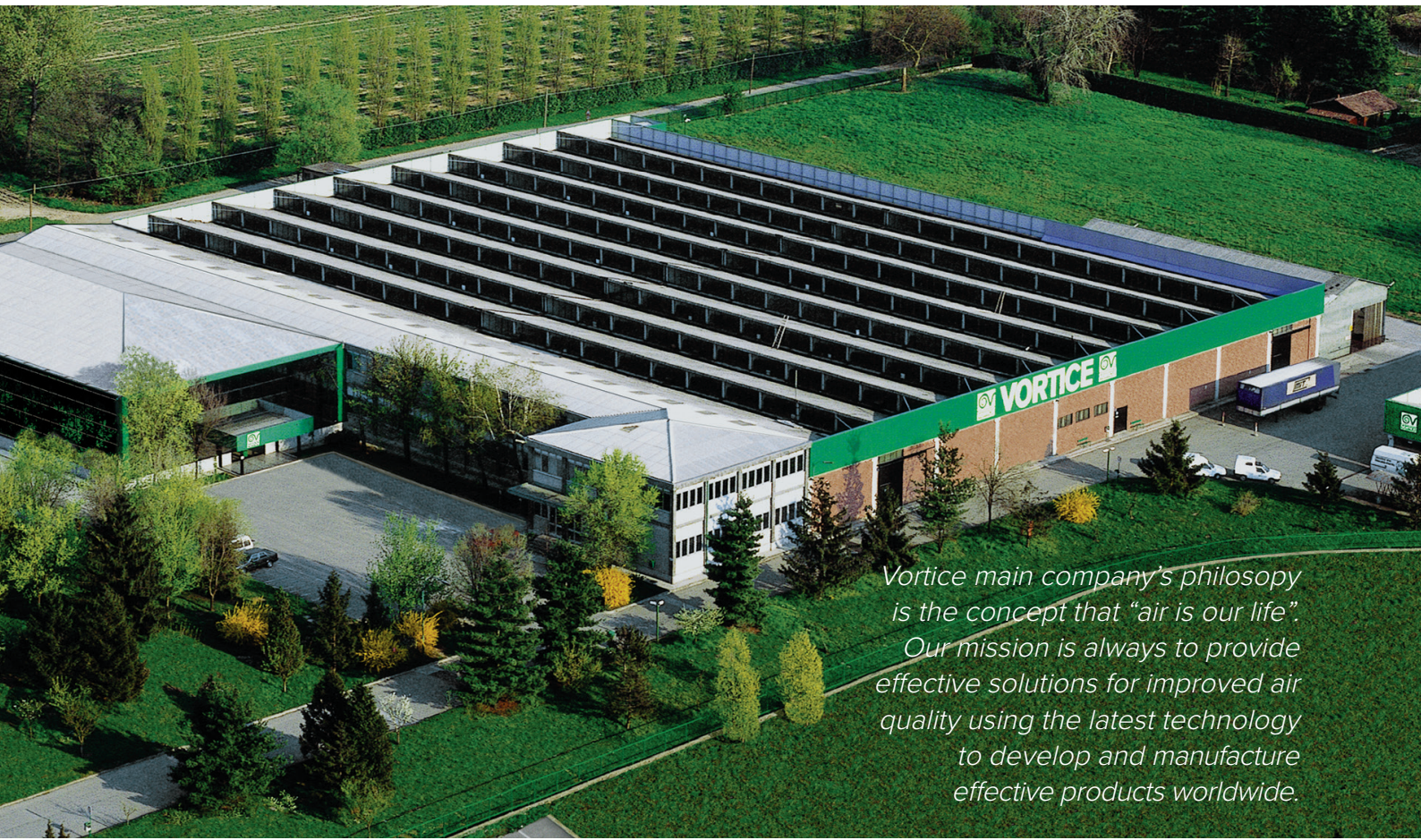

*Vortice main company's philosophy is the concept that "air is our life". Our mission is always to provide effective solutions for improved air quality using the latest technology to develop and manufacture effective products worldwide.*

Our current Vortice Headquarters have been located in Tribiano (Milan) since 1972.

Vortice has achieved European market leadership by dedicating their efforts to the production of products for ventilation, climate control, heating, extraction, purification and the treatment of air, for domestic, commercial and industrial applications. Since 1954 Vortice has been synonymous with quality and excellence and continues to make significant improvements by investing in continuous research to improve the efficiency and quality of its products.

## VORTICE IN THE WORLD

### ENGLAND



Founded in 1977, Vortice Limited is located at Burton on Trent in the East Midlands.

### CHINA



Founded in 2012, Vortice Ventilation System is located about 200 Km from Shanghai.

### SOUTH AMERICA



Founded in 2012, Vortice Latam in San José, Costa Rica.



# INDEX

Why is important to ventilate? ..... pag. 04 Continuous mechanical ventilation	<b>VORT HR 350 EXO RANGE</b> ..... pag. 44 Wall-mounted residential heat recovery unit
<b>VORT HRW 20 MONO RANGE</b> ..... pag. 10 Decentralized heat recovery systems	<b>VORT HRI DH RANGE</b> ..... pag. 50 Ceiling mounted heat recovery unit
<b>VORT HRI MINI RANGE</b> <b>NEW</b> ..... pag. 22 Ceiling-mounted heat recovery systems	<b>VORT HRI PHANTOM RANGE</b> ..... pag. 56 Ceiling-mounted heat recovery systems
<b>VORT PROMETEO PLUS HR 400 RANGE</b> ..... pag. 26 Heat recovery unit	<b>VORT HRI INVISIBLE-E RANGE</b> ..... pag. 62 Ceiling mounted heat recovery unit
<b>VORT HR 300 NETI</b> <b>NEW</b> ..... pag. 32 Wall-mounted heat recovery systems	<b>VORT HA SYSTEM</b> ..... pag. 70 Heat recovery system for false ceiling installation with antibacterial filter
<b>VORT HR 350 AVEL</b> <b>NEW</b> ..... pag. 38 Wall-mounted residential heat recovery systems	<b>VORT HRI FLAT RANGE</b> ..... pag. 72 Ceiling-mounted heat recovery systems

## CE MARKING

Vort Platt EP Range, Vort Penta EP Renge, Vort Leto Mev EP Range conform to the following European Directive:

- 2006/95/ Low Voltage Directive (LVD),
- 2004/108/EC Electromagnetic Compatibility (EMC)

According to the following state-of-the-art standards:

EN 60335-1; EN 60335-2-80; EN 62233;  
EN 55014-1; EN 55014-2; EN 61000-3-2; EN 61000-3-3.



## Why is it so important to VENTILATE?

It is simple, the air we breath  
is very important!

The effect of not having good indoor air quality in the home is dramatic. The average person spends 90% of time indoor and breathing in stale contaminated air can lead to health issues.

Newer houses have become more air tight which means it is harder to get a fresh air path through the building. Breathing in stale contaminated environments can lead to health issues.

Factors that can lead to an  
unhealthy indoor air quality can  
include:

- Building materials;
- Cigarettes fumes;
- Paint fumes;
- Cleaning products (detergents etc);
- Animals;
- Cooking;



The effects of poor indoor  
air quality can lead to a number  
of health issues and allergies:

The air we breathe is vital for our well-being and health. Exposure to a poor indoor environment over long lengths of time could lead to a number of health issues such as:

- Headaches;
- Fatigues;
- Nausea;
- Flu;
- Respiratory Issues such as asthma.



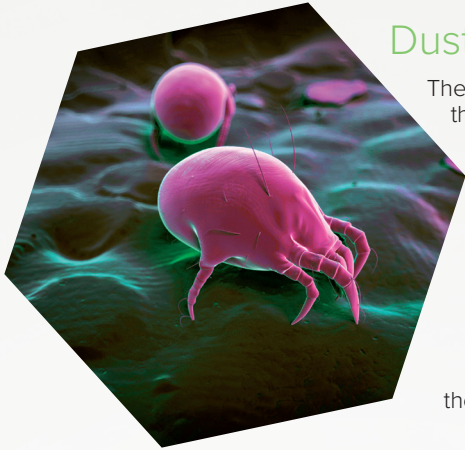

## Dust Mites

The humidity levels within a property are directly linked to the levels of house dust mites and dust mite allergens. By controlling the humidity within the home, dust mites are less able to breed helping asthma sufferers to breathe more easily.

## Condensation

The appearance of condensation on the inside of windows is a frequent and annoying occurrence. The construction of more airtight homes leads to the reduction of natural ventilation and air infiltration within the property. If ventilation is not correctly designed and installed the condensation levels could increase. Increase in condensation levels can result in damp patches on walls and peeling wallpaper. Ventilation is key to removing excess moisture from the property for comfort and good health.

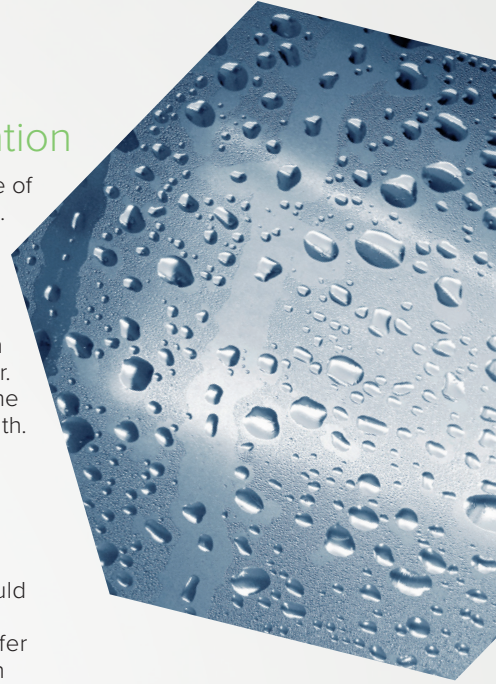

## Mould

Prolonged high levels of humidity and condensation are the main cause of mould growth. Mould spores travel through the air and multiply in damp areas. 1 in 5 homes suffer from issues with mould. Mould is an allergen which can lead to respiratory issues.



*The volatile organic compounds (VOC's) released from paint fumes can have a serious effect on health when breathed for long periods of time.*

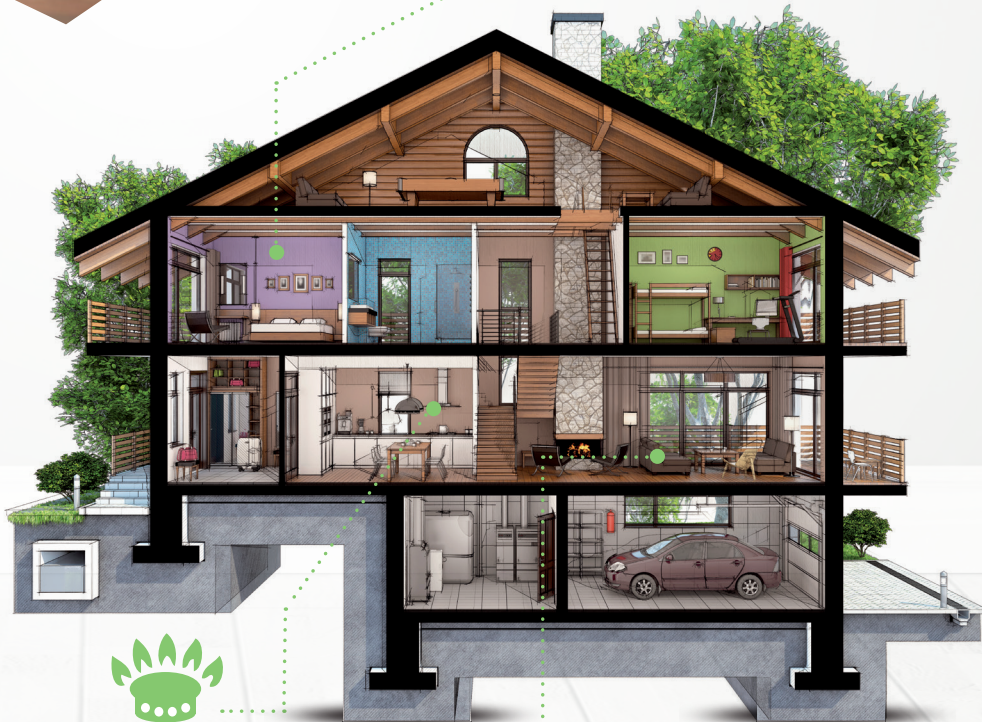

*Cooking using a gas appliance emits nitrogen dioxide, formaldehyde and carbon monoxide. These can lead to the increase of various respiratory and other health ailments.*



*Carpets could harbor dust mites, animal dander and harmful particles.*



## The solution is VENTILATION!

It is simple, the air we breath is very important!

Thanks to the design of various ventilation systems such as **Continuous Mechanical Extract Systems (MEV)** and **Continuous Mechanical Supply and Extract Ventilation with Heat Recovery (MVHR)**. Vortice are able to offer a ventilation system to suit the needs of the homeowner.



### Mechanical Ventilation

In order to provide good air flow control – which is lacking in natural ventilation – a mechanical air handling system can be designed to ensure the proper ventilation. In such systems, the air flow is provided by one or more fans, ducted or not. Systems without ducts consist of one or more fans on the walls or ceiling. The simplest solution is to use one or more extraction fans and a number of openings which enable fresh air to enter the room. These openings can be replaced by intake fans, usually mounted on the walls opposite the extraction fans. This solution is common in industrial environments. In some cases the fans cannot be wall-mounted: in this cases ducts are used to convey the air to the intake or extraction terminals. In residential and commercial environments ducted systems are preferable, since the fans can be located remotely, thus eliminating running noise in the room.

Mechanical ventilation systems have the following advantages:

- controlled air flows
- controlled air streams
- no external noise and limited running noise
- controlled air quality
- reduced thermal losses
- optional energy recovery using heat exchangers.

There are two types of controlled mechanical ventilation system: single flow and double flow.

### Single flow

The air is extracted from the room and conveyed to the exterior through ducting. The fan is usually located outside the room. Fresh air is assured by air inlets usually located on windows or walls. In residential applications, air is usually extracted from “humid” areas (kitchen, bathroom and toilets, washrooms, etc.) while fresh air is delivered to the living room and bedrooms.

In commercial applications, such as offices, fresh air is delivered to the rooms, while extraction is done from corridors via ceiling grilles connected by ducting to the exterior; ducts can be led to the roof, where the fans are usually located.

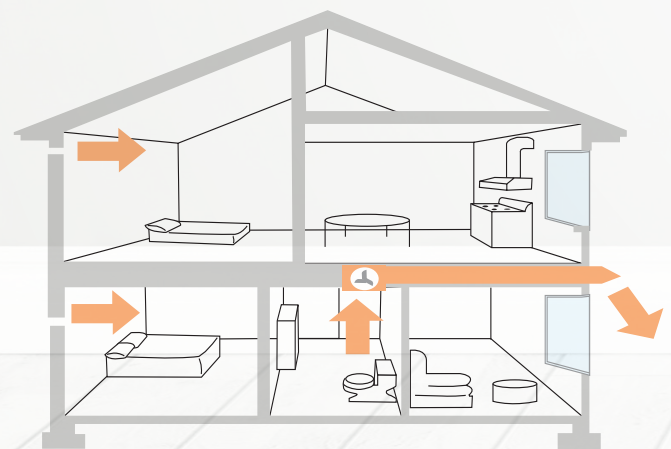

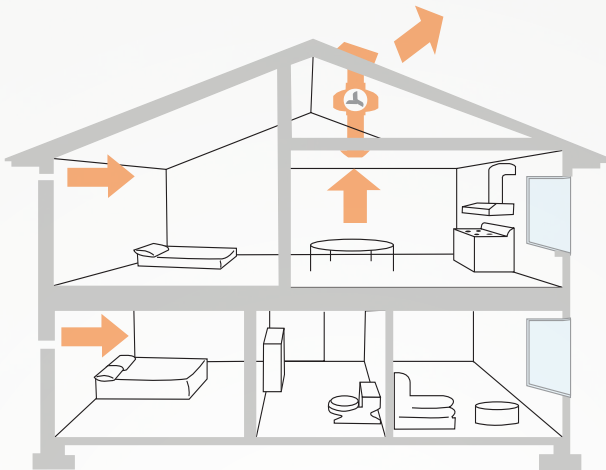

### Advantages

- controlled air flow
- possibility of integration with natural ventilation
- independence from changing weather conditions and occupant behaviour
- adaptable to seasonal conditions
- limited running noise in the rooms
- single room air flow control.

### Disadvantages

- system costs
- no control over the quality of the fresh air
- energy losses
- incoming air too hot in the summer.

## Double flow

A double flow system both extracts air from and delivers it to the room. Extraction is the same as for a single flow system. Delivery is also done using ducts and spigots, but in a separate circuit from the extraction one. The fresh air is driven by a fan into the duct and is delivered to the rooms via diffusers. The delivery and extraction flows are coordinated by a controller.

In more complex systems, the fresh air may be treated before being delivered to the room by filtering, cooling or warming, humidifying or dehumidifying it. Double flow system also enable the use of heat exchangers to recover thermal energy from the expelled air.

### Advantages

- controlled air flow
- optional use of heat recovery unit
- possibility of integration with natural ventilation
- independence from changing weather conditions and occupant behaviour
- adaptable to seasonal conditions
- limited running noise in the rooms
- possibility of control over the quality of the fresh air
- single room air flow control

### Disadvantages

- system costs

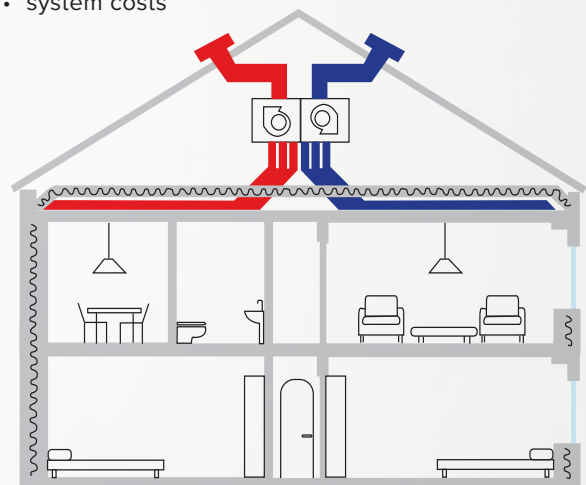

### Filters

To ensure a healthy indoor air quality Vortice offer many different grades of filters for their ventilation units which filter dust particles, pollen and fumes. Filtration on Heat Recovery units is imperative to ensure the incoming air is filtered as to not introduce external pollutants into the home. Vortice have thought about the importance of indoor air quality by ensuring their heat recovery units have a 100% fully filtered system. **This feature is particularly useful when installing in areas of high pollution (apartment blocks in inner cities).**

## Heat RECOVERY unit

A heat recovery unit is a double flow ventilation unit: it not only delivers fresh air to the rooms, but also extracts stale air. The two flows exchange heat within the machine itself (the heat exchanger) so that the warmer flow delivers a part of its thermal energy to the colder flow. In a typical configuration, the heat recovery unit is not a heat generator nor a chiller, so it must be used in combination with a normal heating or A/C system. The machine has the following main components:

### Filters

the machine is usually equipped with filters to protect the fan motors against dust, and above all to filter both the extracted and delivered air.

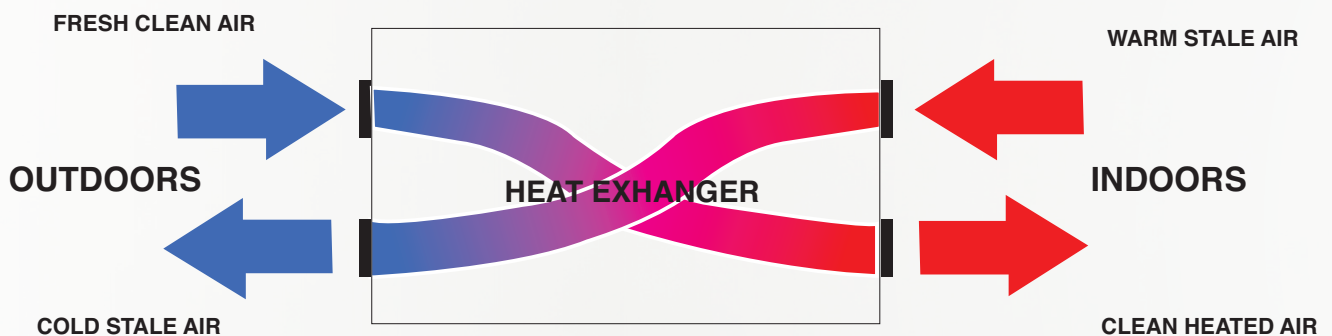

### Housing

contains the various components of the machine and insulates it acoustically.

It can be made with galvanized sheeting, sheet with a plastic film coating, with single or double panels, or plastic. It may be equipped with acoustic insulation to reduce running noise.

### Fans

the fans drive the air: the unit includes an intake fan (delivers air from outdoors to the interior) and an extraction fan (from the interior to outdoors).

### Heat exchanger

this is the principal component, which provides the exchange of heat energy between the two flows. There are various types of exchanger.

### Advantages of heat recovery units

- They are double flow units: they renew the air into the room.
- Filters keep pollution under control.
- They pre-heat or pre-chill the renewed air by recovering energy at zero cost from the extraction flow, energy which would be lost in a ventilation system not equipped with heat recovery.
- Thanks to energy recovery it is possible to use smaller heating and A/C units (boilers, air conditioners, roof-top units, water chillers, etc.).
- They reduce the wear of heating/cooling system equipment.
- Over time, the initial investment is paid back by savings in total running costs.



# Energy EFFICIENCY



## Energy

- They are double flow units: they renew the air into the room.
- Filters keep pollution under control.
- They pre-heat or pre-chill the renewed air by recovering energy at zero cost from the extraction flow, energy which would be lost in a ventilation system not equipped with heat recovery.

There are various definitions of energy efficiency or thermal exchange efficiency ( $\eta$ ) of a heat recovery unit. It generally refers to the ratio between the real difference ( $\Delta T(\text{real})$ ) and the theoretical difference ( $\Delta T(\text{theoretical})$ ) of the incoming and outgoing air temperatures (supposing both flows to be equal in mass):

$$\eta = \frac{\Delta T(\text{real}) / \Delta T(\text{theoretical})}{(T \text{ intake} - T \text{ outdoors}) / (T \text{ indoors} - T \text{ outdoors})}$$

Some practical examples to understand the importance of heat exchangers efficiency:

Outdoors air: -5 °C  
Indoors air: +20°C  
Air delivery via exchanger: to be calculated

$$\Delta T_{(\text{theoretical})} = 20 - (-5) = 25 \text{ °C}$$

$$\Delta T_{(\text{real})} = \eta * (\Delta T_{(\text{theoretical})}) = \eta * 25, \text{ so that}$$

$$T \text{ intake} = \eta * 25 + T \text{ outdoors}$$

A heat exchanger with efficiency  $\eta = 50\%$  thus gives a delivery air temperature of:

$$T \text{ intake} = 0.5 * 25 + (-5) = 7.5 \text{ °C} \rightarrow$$

cold air is delivered to the room.

Otherwise, if the exchanger's efficiency is  $\eta = 80\%$ , we have:  $T \text{ intake} = 0.8 * 25 + (-5) = 15 \text{ °C}$ .

while if efficiency  $\eta = 90\%$ , we have:  
 $T \text{ intake} = 0.9 * 25 + (-5) = 17.5 \text{ °C}$ .

## ES thanks to brushless motors

The high-efficiency EC-DC brushless motor equipped in ES models provides a really significant energy saving, unconceivable with regular AC motors.

The Energy Saving models (ES) are marked with a special Green symbol.

This type of motor enables to classify products as "Energy Saving", for two reasons:

- they reduce specific consumption (lower consumption for the same performance, with efficiency greater than 80%, against the 30-40% of AC motors);
- thanks to their modulability, which means that they work efficiently over a much wider range of speeds, they are able to adapt their output to the real needs of the moment.





# VORT HRW 20 MONO RANGE

Decentralized heat recovery systems

Decentralised ventilation unit with heat recovery, designed specifically for ventilation in residential and commercial environments in new or restored buildings, characterised by high levels of heat insulation. Easy to install and maintain, the appliances in the VORT HRW MONO series represent an ideal alternative to traditional dual flow centralised ventilation systems.

- 3 models, also in version with relative humidity sensor, with integrated or remote controls, compatible with recessed housing in standard UNI 503 and DIN boxes.
- Wall-mounted frames and white, self-extinguishing (V0), shock-proof internal plastic resin (ABS) panels, which are also “UV resistant”.
- The panels, which are lined internally with heat-insulating material to prevent the formation of condensate, do not have any frontal openings (perimeter extraction and delivery) for better aesthetics that blend into the room perfectly.
- In the VORT HRW 20 MONO and VORT HRW 20 MONO HCS models, the frames house the control units, the electric fan power pack and the relative humidity sensor and incorporate the ventilation duct spigot. There are also set-ups for chased wiring.
- Expanded polypropylene casing (PPE), designed for housing in a hole, with nominal diameter of 160 mm, made in the perimeter wall.
- Moulded rubber outer grille, which can be mounted from the inside through the hole prepared to simplify start-up of the product. They include an anti-insect mesh, which can be easily removed for cleaning interventions.
- EC electric motors, guaranteeing very low consumption, powered at low voltage and with shaft mounted on ball bearings. Characterised by 5 operating speeds, to promote the best balance between handled air flow rate, consumption and noise emission. They are designed to operate clockwise and anti-clockwise and thus allow the product to operate in Extraction, Ventilation and Ventilation with heat recovery modes.
- High efficiency storage heat exchangers, made in ceramic material and hexagonal cells to maximise the heat exchange surface. In the winter operating mode (in summer the logic is inverted), thanks to the periodic inversion of the direction of rotation of the electric fan, the fill is cyclically heated by the hot air extracted and successively transfers most of this heat to the cold fresh air entering.
- G3 filters that can be washed and are easily accessible for maintenance/cleaning.
- Pre-filters, housed in correspondence with the external façade side.
- The VORT HRW 20 MONO models, designed to maximise the simplicity of installation, are complete with control units incorporated in the wall-mounted frames, for switch-on, switch-off and selection of the product operation mode and speed. The filter status diagnostic and signalling LED as well as the electric fan power pack are also housed here.
- The VORT HRW 20 MONO HCS models differ from previous models due to the presence of a relative humidity sensor (RH), with threshold value that can be set on installation at 60%, 70%, 80% or 90%, for automatic switch-over to Extraction mode when the RH concentration in the room exceeds the pre-fixed limit.
- The VORT HRW 20 MONO RC models, studied to minimise the aesthetic impact of the product installed, are characterised by a wall-mounted frame with very small thickness (only 17 mm). They are coupled with the HRW RC wired remote control unit, (available as an accessory), can be wall-mounted and recessed in a UNI 503 Standard compliant box.
- Protection rating from dusts and water: IPX4
- Class of electric isolation: II (earthing not required).

VORT HRW MONO  
(code 11634)

VORT HRW MONO HCS  
(code 11631) 

VORT HRW MONO RC  
(code 11635)

## KEY FEATURES

- Ideal for decentralised Controlled Mechanical Ventilation with heat recovery.
- Possibility of controlling up to 4 units with integrated power pack.
- High heat exchange efficiency and very low electric consumption.
- Noise lower than 16 dbA.
- Ventilation duct can be closed to prevent the entry of pollutants when the appliance is off.

Rubber made grille, to easy mount from outside or even from inside, without any scaffolding.

High efficiency ceramic made heat accumulator.

High efficiency EC motor extremely low power consumption

Inner panel made of V0 self-extinguishing

Mesh, to be inserted in the duct together with the external grille at installation.

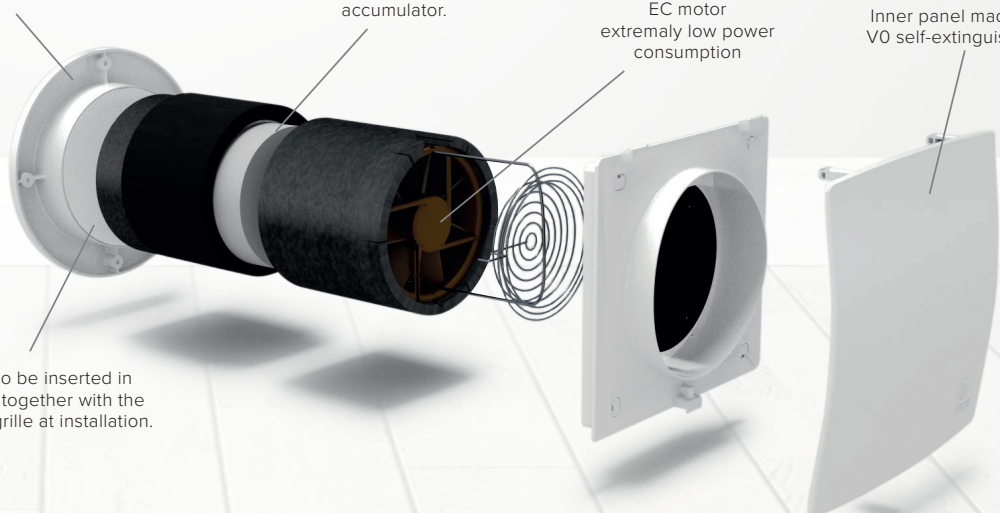



# VORT HRW 20 MONO RANGE

Decentralized heat recovery units

## CONTROL PANEL VORT HRW 20 MONO AND VORT HRW 20 MONO HCS

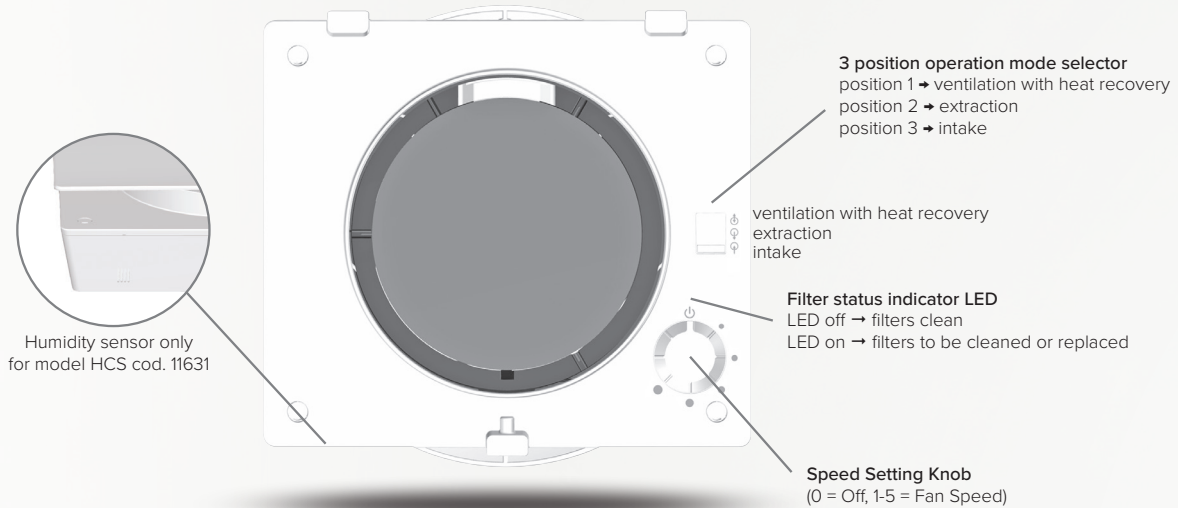

## REMOTE CONTROL VORT HRW 20 MONO RC

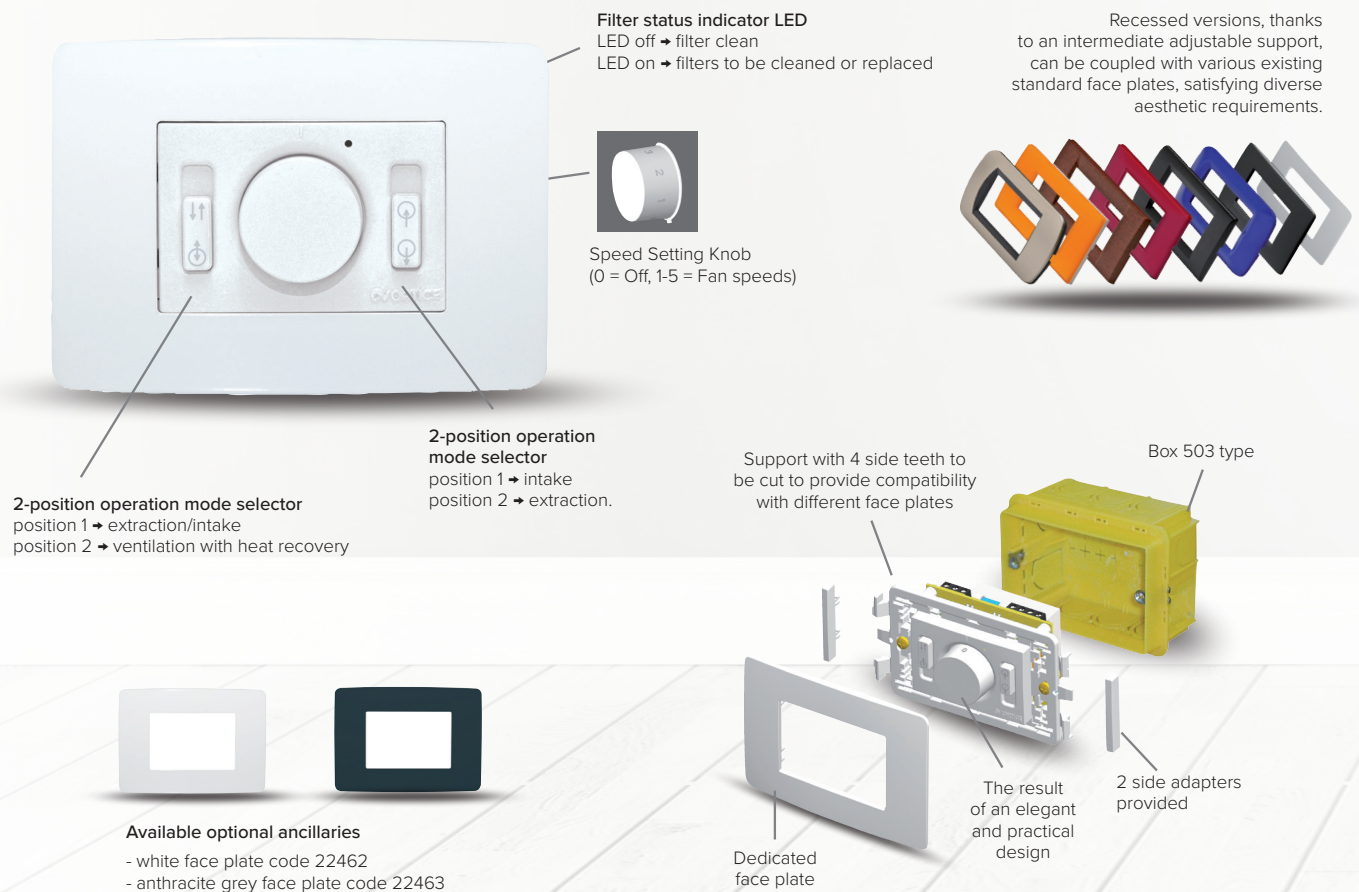



## TECHNICAL DATA

MODELS	CODE	V~50/60HZ	W min/max	A min/max	MAX FLOW RATE		MAX PRESSURE		Lp dB(A) 3m min/max	°C* max	Kg
					m³/h min/max	l/s min/max	mmH <sub>2</sub> O min/max	Pa min/max			
VORT HRW 20 MONO	11634	220-240	1.0 5.5	0.015 0.053	10 40	2.77 11.1	0.64 4.10	6.2 40.6	<16.0 23.6	30	2.55
VORT HRW 20 MONO RC	11635	220-240	1.0 5.5	0.015 0.053	10 40	2.77 11.1	0.64 4.10	6.2 40.6	<16.0 23.6	30	2.25
VORT HRW 20 MONO HCS	11631	220-240	1.0 5.5	0.015 0.053	10 40	2.77 11.1	0.64 4.10	6.2 40.6	<16.0 23.6	30	2.60

## ENERGY DATA

Code	Unit of measurement	VORT HRW 20 MONO HCS	VORT HRW 20 MONO	VORT HRW 20 MONO RC
		11631	11634	11635
Supplier's name or trade mark	-	Vortice	Vortice	Vortice
Specific Energy Consumption class SEC in average climate zone	-	NA*	NA*	NA*
Specific Energy Consumption class SEC average	-	- 37.2	- 37.2	- 37.2
Specific Energy Consumption class SEC cold	kWh/m² year	- 80.8	- 80.8	- 80.8
Specific Energy Consumption class SEC warm	-	- 12.3	- 12.3	- 12.3
Declared typology	-	URVU*	URVU*	URVU*
Type of drive	-	VSD**	VSD**	VSD**
Type of heat recovery system HRS	-	regenerative	regenerative	regenerative
Thermal efficiency of heat recovery at reference air flow	%	90	90	90
Maximum flow rate [m³/s]	m³/h	31	31	31
Electric power input of the fan drive, including any motor control equipment, at maximum flow rate	W	5.1	5.1	5.1
Sound power level LWA	LWA [dB(A)]	44	44	44
Reference flow rate	m³/s	0.006	0.006	0.006
Reference pressure difference	Pa	19	19	19
SPI***	W/(m³/h)	0.23963	0.23963	0.23963
Control factor CTRL	-	1	1	1
Control typology	-	manual	manual	manual
Maximum internal leakage rates	%	NA*	NA*	NA*
Maximum external leakage rates	%	NA*	NA*	NA*
Mixing rate	-	NA*	NA*	NA*
Position and description of visual filter warning	-	NA*	NA*	NA*
Airflow sensitivity to pressure variations at + 20Pa and - 20 Pa	-	0.27	0.27	0.27
Indoor/outdoor air tightness	m³/h	NA*	NA*	NA*
Annual electricity consumption (AEC)	kWh electricity/year	330	330	330
AHS average Annual heating saved	-	4550	4550	4550
AHS cold Annual heating saved	kWh primary energy/year	8901	8901	8901
AHS warm Annual heating saved	-	2057	2057	2057

\*BRVU: Bidirectional Residential Ventilation Unit  
\*URVU: Unidirectional Residential Ventilation Unit

\*\*VSD: Variable Speed Drive  
\*\*MSD: Multi Speed Drive

\*\*\*SPI: Specific Power Input

NA: data not applicable



# VORT HRW 20 MONO RANGE

Decentralized heat recovery units

## PERFORMANCE CURVES

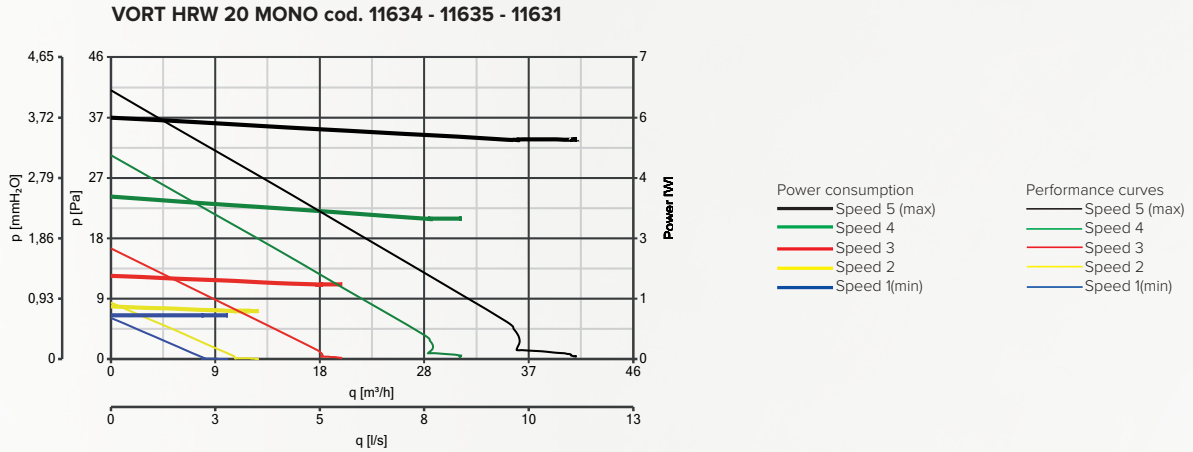

## DIMENSIONS

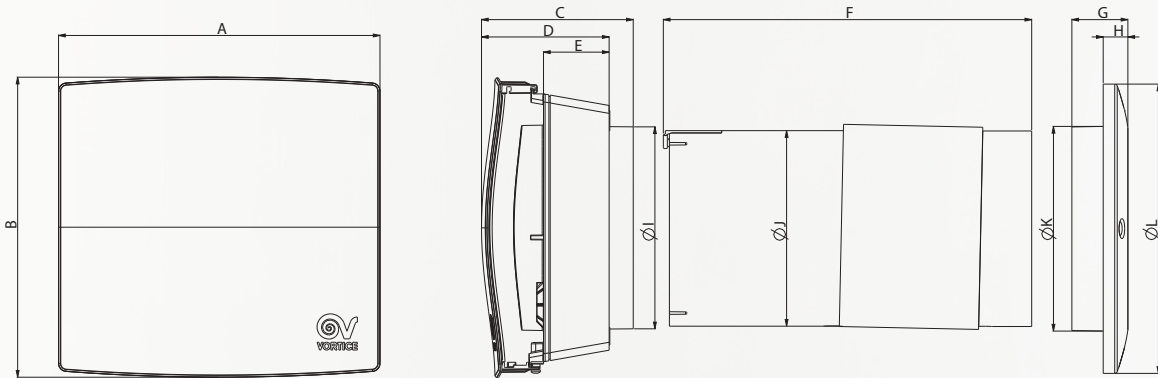

VORT HRW 20 MONO (code 11634)  
VORT HRW 20 MONO HCS (code 11631)

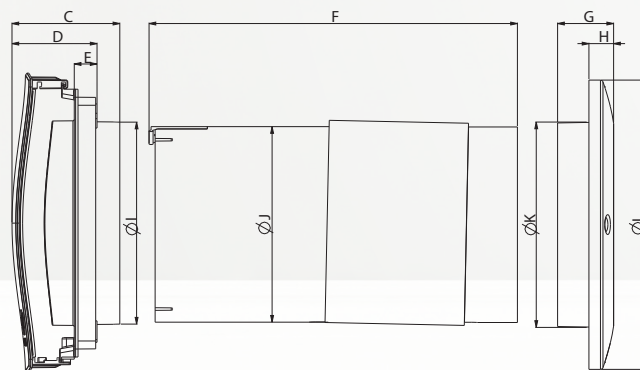

VORT HRW 20 MONO RC (code 11635)

MODELS	A	B	C	D	E	F	G	H	ØI	ØJ	ØK	ØL
VORT HRW 20 MONO	240	224	113	95	49	275	42	18	151	146	153	216
VORT HRW 20 MONO RC	240	224	80	64	17	275	42	18	151	146	153	216
VORT HRW 20 MONO HCS	240	224	113	95	49	275	42	18	151	146	153	216

Dimensions in mm





# VORT HRW 20 MONO D NEW

Decentralized heat recovery units

Decentralized ventilation system with heat recovery, high efficiency, suitable for recessed installation (nominal hole diameters 160 mm) in outside walls of thickness between 300 mm and 700 mm. Quiet, efficient, energy saving and antiallergic (thanks to built-in filters preventing the release of pollutants and allergens into the surrounding air), easy to install and maintain, the VORT HRW 20 MONO D (code 11671), represents the ideal alternative to traditional dual flow centralized ventilation systems.

- Recessed wall-mount installation with housing made of expanded polypropylene (PPE).
- Internal panel made of self-extinguishing plastic polymer (ABS V0), coated with heat-insulating material to avoid condensation and designed without frontal vents so as to blend effortlessly into the interior decor (peripheral intake and outlet vents). Provision made for chased wiring.
- External grille made of plastic resin, complete with fly screen.
- Fan unit with EC motor, guaranteeing ultra low energy usage, powered at low voltage and with shaft mounted on ball bearings to ensure virtually “maintenance free” operation. 5 fan speeds, favouring selection of the best balance between volume of air handled, power consumption and noise level.
- High efficiency storage heat exchanger, made of ceramic honeycomb material designed to maximize the heat exchange surface.
- G3 filter, mounted in separate frame to facilitate user serviceability, washable and easily accessible for cleaning and maintenance.
- Mesh prefilter housed adjacent to the external grille.
- Wired remote control unit supplied as standard accessory (code 21145), wall-mounted and compatible with DIN standard circular back box, diameter 60 mm. Complete with circuit board designed for use in combination with three alternative power adapters (optional), in versions for recessed mounting or panel installation (DIN rail) and designed to serve a maximum of 4 or 6 products, the control unit includes 2 LEDs (indicating the operational status of the product and warning when the filter is clogged) and is factory prepared for use in combination with IR remote control.
- Protection rating: IPX4.
- Insulation class: II

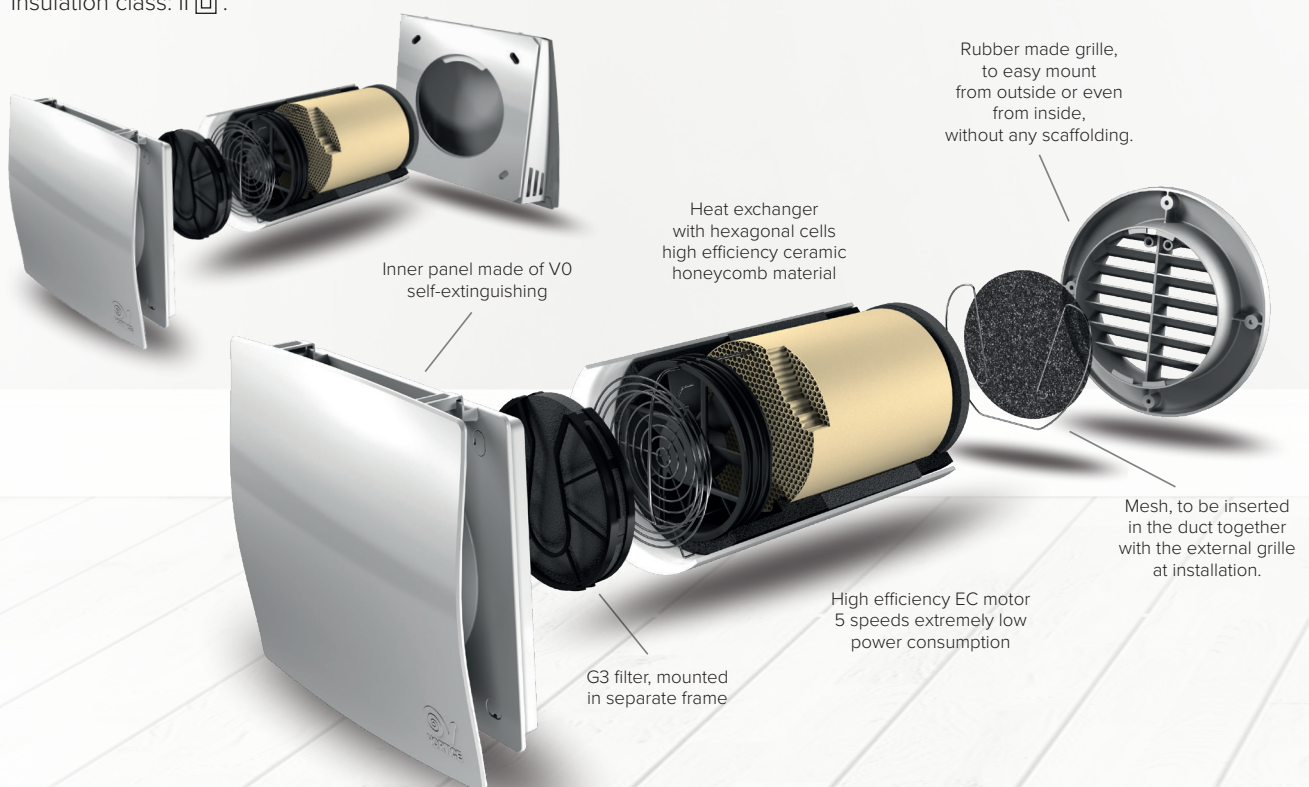



VORT HRW 20 MONO D  
(code 11671)



## KEY FEATURES

- Ultra low power consumption (2.8 W to 8.6 W), perfectly compatible with operation 24/7.
- High heat exchange efficiency (up to 89%), certified by independent body, guaranteeing comfort and minimal waste of energy.
- Extremely low noise levels, compatible with installation in living rooms (lounge, study, bedroom), and use during the night.
- Offering compact dimensions, plus ease of installation and set-up, these VORT HRW 20 MONO D units are ideal both for new buildings and for renovation projects.
- Wide range of alternative operating modes, allowing selection of the best balance between performance, power consumption and noise levels.
- Simple and intuitive to use.
- Ventilation duct with damper mechanism, to prevent the risk of contaminants entering from outside and maximize heat insulation in the event that the room will not be occupied for extended periods.
- Facility of operation in conjunction with an extractor fan, to ensure continuous and correct ventilation of the dwelling.
- Option of operation in automatic mode, enabled by installing temperature and relative humidity sensors (optional).
- Possibility of installation on outside walls of thickness between 300 mm and 700 mm (with optional accessory).
- Operation permissible across a wide range of outdoor temperatures (-20° / 50° C).



# VORT HRW 20 MONO D NEW

Decentralized heat recovery units

## TECHNICAL DATA

VORT HRW 20 MONO D code 11671					
Speed	1	2	3	4	5
Supply/extract airflow at different speed levels m <sup>3</sup> /h	9	16	25	33	36
Sound pressure breakout LPA dB(A)*	24,5	26,9	32,8	38,9	44,5
Fan power W	2	2,7	3,7	5,0	5,6
Heat recovery efficiency	up to 89%				
Supply voltage V	input 230 V - 50/60 Hz /output 12 V				
Nominal current A	0,026	0,035	0,048	0,056	0,057
Weight Kg	2,55w				
Temperature Max °C	-20° C / 50° C				

\* Sound pressure measurement was performed according to UNI EN ISO 3741:2010

## ENERGY DATA

	Code	Unit of measurement	VORT HRW 20 MONO D 11671
Supplier's name or trade mark	-	-	Vortice
Specific Energy Consumption class SEC in average climate zone	-	-	NA*
Specific Energy Consumption class SEC average	-	-	- 40.2
Specific Energy Consumption class SEC cold	-	kWh/m <sup>2</sup> year	- 83.4
Specific Energy Consumption class SEC warm	-	-	2.5
Declared typology	-	-	URVU*
Type of drive	-	-	VSD**
Type of heat recovery system HRS	-	-	regenerative
Thermal efficiency of heat recovery at reference air flow	-	%	89
Maximum flow rate [m <sup>3</sup> /s]	-	m <sup>3</sup> /h	32
Electric power input of the fan drive, including any motor control equipment, at maximum flow rate	-	W	5.1
Sound power level LWA	-	LWA [dB(A)]	44.6
Reference flow rate	-	m <sup>3</sup> /s	25
Reference pressure difference	-	Pa	19
SPI***	-	W/(m <sup>3</sup> /h)	0.12598
Control factor CTRL	-	-	1
Control typology	-	-	manual
Maximum internal leakage rates	-	%	NA*
Maximum external leakage rates	-	%	NA*
Mixing rate	-	-	NA*
Position and description of visual filter warning	-	-	NA*
Airflow sensitivity to pressure variations at + 20Pa and - 20 Pa	-	-	0.27
Indoor/outdoor air tightness	-	m <sup>3</sup> /h	NA*
Annual electricity consumption (AEC)	-	kWh electricity/year	174
AHS average Annual heating saved	-	-	4515
AHS cold Annual heating saved	-	kWh primary energy/year	2732
AHS warm Annual heating saved	-	-	2042

\*BRVU: Bidirectional Residential Ventilation Unit  
\*URVU: Unidirectional Residential Ventilation Unit

\*\*VSD: Variable Speed Drive  
\*\*MSD: Multi Speed Drive

\*\*\*SPI: Specific Power Input

NA: data not applicable

PERFORMANCE CURVES

VORT HRW 20 MONO D code 11671

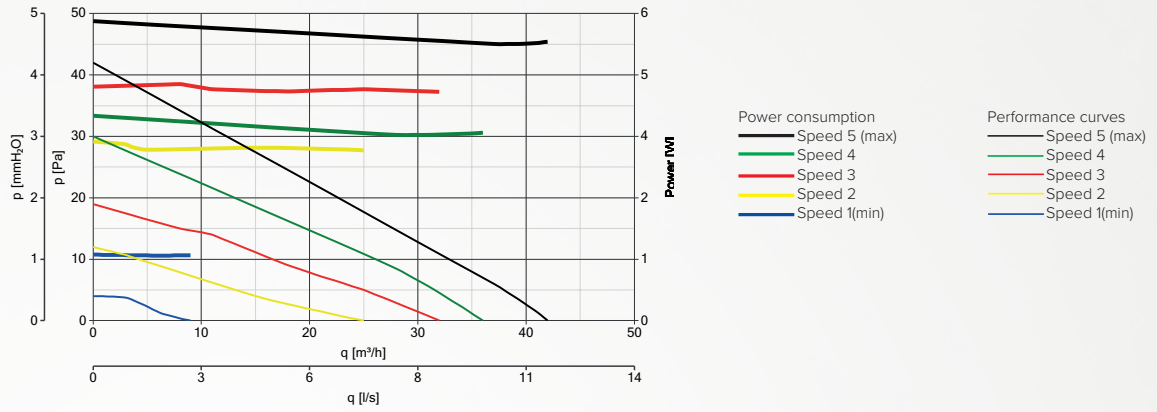

DIMENSIONS

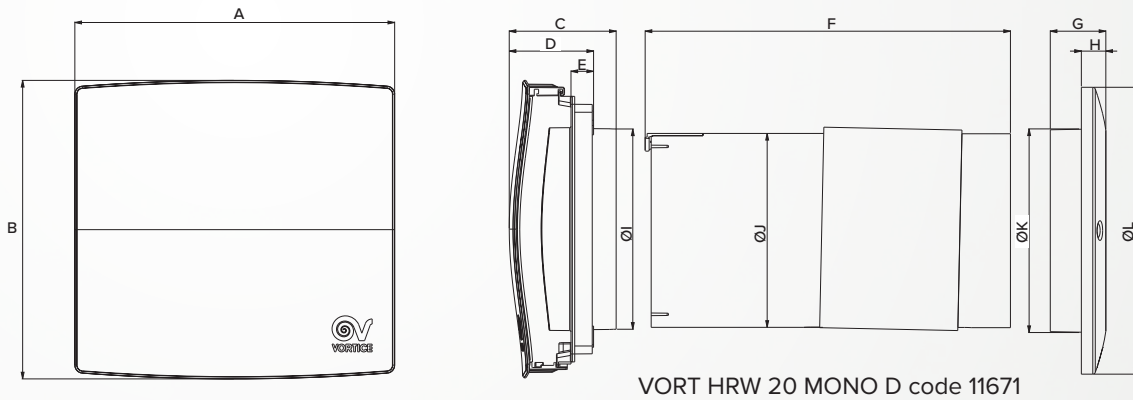

MODELS	CODE	A	B	C	D	E	F	G	H	Ø I	Ø J	Ø K	Ø L
VORT HRW 20 MONO D	11671	240	224	80	64	17	275	42	18	151	146	153	216

Dimensions (mm)



# VORT HRW 20 MONO RANGE

Decentralized heat recovery units

## ACCESSORIES ON REQUEST FOR ALL MODELS



RGR - code 21190  
Flexible grille  
no external scaffolding



WA - code 21191  
Adapter circular/rectangular  
for window grille mounting



WSG-INOX - code 21192  
Rectangular grille for WA kit  
stainless steel

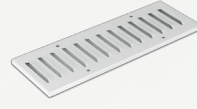

WSG-W - code 21193  
Rectangular grille for WA kit  
white finish



HRW PVC Duct  
- code 22599  
PCV duct Ø 160 mm  
L= 700 mm



M5 filter - code 22699  
Filter



code 22466  
Filter Kit  
for HRW 20 MONO



MWS - code 21148  
Metallic outer grille



MWS-A - code 21219  
Outside stainless steel  
windshield panel

## CONTROLS ON REQUEST FOR MODELS 11634, 11635, 11671



C TEMP - code 12992  
Temperature sensor



C SMOKE - code 12993  
Smoke sensor



C HCS - code 12994  
Humidity sensor

## ACCESSORIES ON REQUEST FOR VORT HRW MONO RC CODE 11635



Box 503 - code 22461  
Flush mounting box 503



HRW RC - code 22693  
Remote unit control



Built-in box - code 22732  
Built-in box for code 12993

## ACCESSORIES ON REQUEST FOR VORT HRW MONO D CODE 11671

HRW RCD D - code 21145  
Remote control

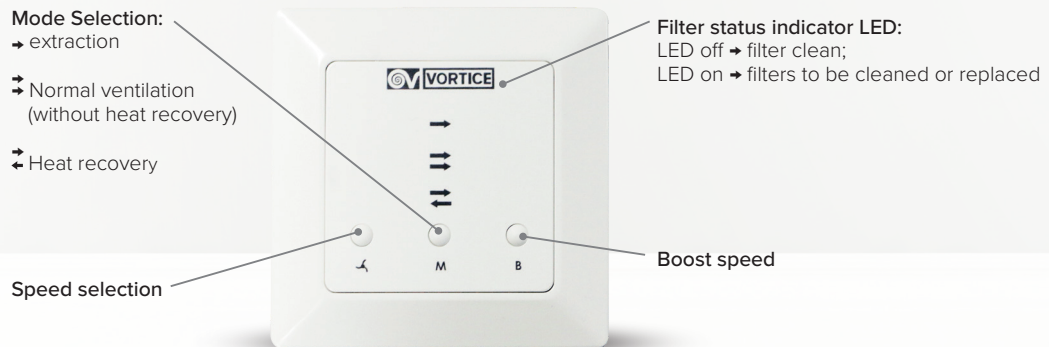

PS24W - code 21187  
Power supply for wall  
mounting - up to 4 units



PS36W - code 21188  
Power supply for wall  
mounting - up to 6 units



PS36WDIN - code 21189  
Power supply for electrical panel (DIN  
bar) - up to 6 units



### A

Ceiling-mounted dual flow centralised ventilation unit with heat recovery. Ideal for efficient ventilation of homes, hotel rooms or general premises with surface area up to 80 m<sup>2</sup> characterised by high levels of heat insulation.

- 1 model.
- Galvanised steel sheet casings incorporating the support brackets for ceiling-mounting. Body lined with fireproof, sound-proofing and heat insulating material (DIN EN 13501).
- Extraction and delivery spigots compatible with pipes having nominal diameter of 100 mm and 125 mm.
- Pair of electric fans driven by external rotor EC motors (brushless) with shafts mounted on ball bearings, directly coupled to backward-curved centrifugal impellers for high aeraulic efficiency. 2 operating speeds that can be set independently on installation, managed by the control electronics incorporating monitoring of any malfunctioning, which is recorded in the memory of the micro-controller.
- High efficiency counter cross flow heat exchanger, made in plastic resin (PS).
- Automatically activated anti-freeze protection to prevent the formation of frost at the heat exchanger.
- Thermodynamic by-pass, with manual and automatic activation and 100% filtered to guarantee the comfort of the occupants of the rooms in mid-season, or however when the outdoor temperature does not require the action of the heat exchanger.
- Wired remote control unit supplied as per standard, which allows:
  - the choice of minimum or maximum product operating speed;
  - the manual opening/closing of the thermodynamic by-pass;
  - setting product operation in Manual or Automatic mode (see instruction book);
  - indication of the condition of the saturated filters via luminous LED.
- Pair of G2 filters in correspondence with the extraction and delivery spigots.
- Condensate collection tray with overflow protection and drain devices.
- Extraction grille complete with mesh filter.
- Protection rating from dusts and water: IPX2.
- Class of electric isolation: I (earthing not required).





## KEY FEATURES

---

- Ceiling installation.
- Particularly small clearance and weight.
- Suitable for studio apartments and two-roomed apartments, hotel bedrooms.
- Low energy consumption.



# VORT HRI MINI RANGE NEW

Ceiling-mounted heat recovery systems

## TECHNICAL DATA

MODELS	CODE	V~50HZ	W min/max	A min/max	MAX FLOW RATE		MAX PRESSURE		°C* MAX	Kg
					m³/h min/max	l/s min/max	mmH <sub>2</sub> O min/max	Pa min/max		
HRI MINI	12163	230	6 86	0.1 0.37	64 122	17 34	10 20	100 200	40	8.3

\* Product continuous operation maximum temperature.

## ENERGY DATA

	Unit of measurement	HRI MINI 12163
Manufacturer's name or brand name	-	Vortice
Specific energy consumption class for temperate climate	-	A
Specific energy consumption sec (temperate climate)	-	-39.4
Specific energy consumption sec (cold climate)	kWh/m <sup>2</sup> year	-78.4
Specific energy consumption sec (hot climate)	-	-14.4
Type of ventilation unit declared	-	UVR-B**
Type of drive	-	VSD***
Type of heat exchanger system HRS	-	with recovery
Heat efficiency of heat recovery at the reference flow rate HRS	%	87.7
Maximum flow rate	m <sup>3</sup> /h	103
Total electric power absorbed by the fan at maximum flow rate	W	79.0
Sound power level	LWA [DB(A)]	42
Reference flow rate	m <sup>3</sup> /s	0.0200
Reference pressure difference	Pa	50
SFI****	W/(m <sup>3</sup> /h)	0.50000
Control factor CTRL	-	0.65
Type of control	-	room env.
Maximum percentage of internal leakage	%	5
Maximum percentage of external leakage	%	5
Rate of mixture	-	NA*
Position and description of the filters visual signal	-	NA*
Sensitivity of the air flow to pressure changes at ± 20 PA	-	NA*
Internal/external air sealing	m <sup>3</sup> /h	NA*
AEC annual consumption of electricity	kWh of electricity/year	310
AHS annual heating saved with temperate climate	-	4646
AHS annual heating saved with cold climate	kWh of primary energy/year	9088
AHS annual heating saved with hot climate	-	2101

Energy data pursuant to 1254/2014 EU Regulation

\* NA: Not Applicable.

\*\* UVR-B: Residential Ventilation Unit - Bidirectional.

\*\*\* VM: Multiple Speed. VSD: Variable Speed Drive.

\*\*\*\* SFI: Specific absorbed power.



**DIMENSIONS**

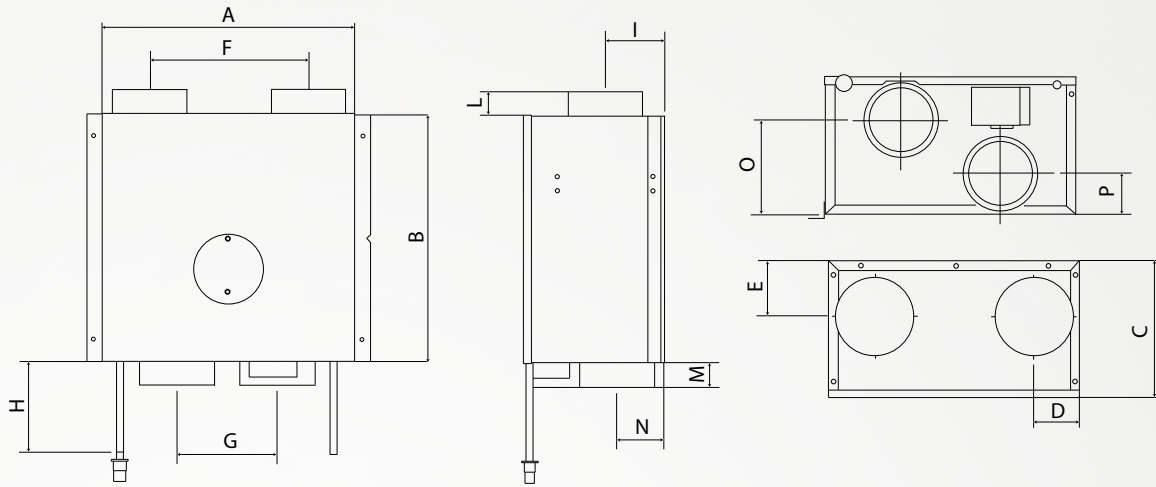

MODELS	CODE	A	B	C	D	E	F	G	H	I	L	M	N	O	P
HRI MINI	12163	396	396	220	74	89	252	160	150	94	40	40	73	150	67

Dimensions (mm)

**SOUND LEVELS**

HRI MINI	Lw db (A)	Lp db (A) 3 m*
Supply to internal	43.3	22.8
Extract to internal	36.5	16
Breakout	43.1	22.5

Tests carried out according EN9614 standard. Sound pressure calculated at 3 m distance in free-field.

**PERFORMANCE CURVES**

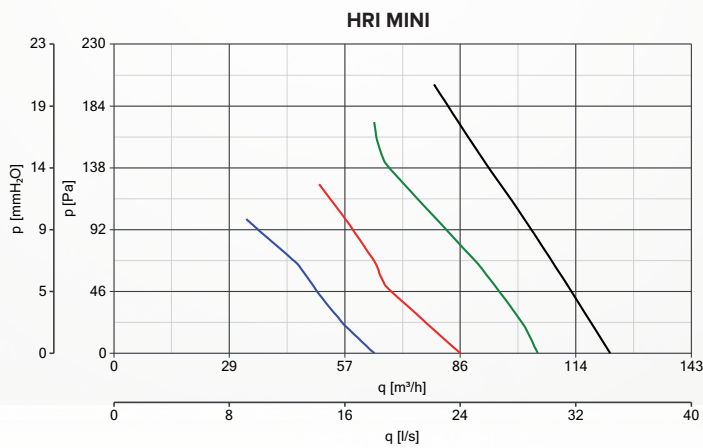

**ACCESSORIES**



Box 503 - code 22461  
Flush mounting box 503



code 12868  
HRI MINI CB



# VORT PROMETEO PLUS HR 400 RANGE

Heat recovery units

A

Dual flow centralised unit with heat recovery for floor and wall horizontal or vertical installation. Ideal for ventilation of homes and residential and commercial premises with surface areas up to 240 m<sup>2</sup>.

- Materials: fire-resistant expanded polypropylene (PPE); front panel made of filled thermoplastic resin
- Duct connection ports of nominal diameter 150 mm
- 2 x EC brushless motor with shafts turning in ball bearings, each coupled to a backward curved centrifugal impeller; 3 speeds, selectable independently at the moment of installation.
- Air flow settable between 50 m<sup>3</sup>/h and 380 m<sup>3</sup>/h
- Ultra high-efficiency counter-flow type heat exchanger fashioned from moulded plastic
- Automatic or manual operation
- 100% bypass, automatic or manual control
- Equipped with two way radio remote control used for the purposes of initial setting, selection of operating mode and diagnostics.
- Filter clogging status monitored automatically
- Equipped with Temperature + Relative Humidity (R.H.) sensor and CO<sub>2</sub> sensor, providing signals that will control operating speed automatically, achieving the best possible balance between quality of the ambient air, energy consumption and noise emissions.
- Automatically activated system designed to prevent icing of the heat exchanger.
- 2 x M5 filter (option of additional F7 filter on outlet duct)
- condensate drain hose;
- pipette for connection of drain hose
- silencer of nominal diameter 150 mm and length 0.5 m, for installation downstream of the appliance on the supply duct connecting with the rooms.
- 2 x metal bracket for suspended vertical mounting of the appliance;
- 4 x mount for horizontal installation
- Energy performance certified by CASACLIMA (Italy), BRE (UK), CETIAT (France), EPBD (Belgium)

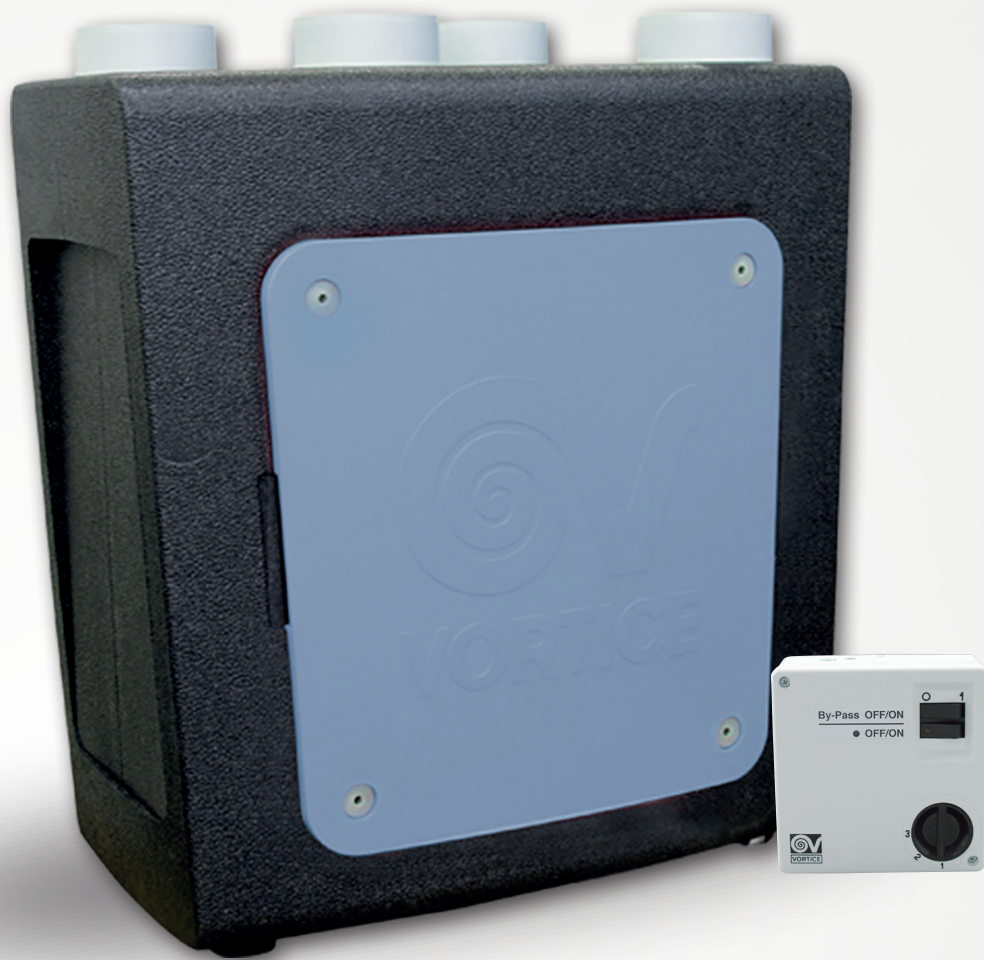

## KEY FEATURES

---

- High (up to 93%) heat exchange efficiency.
- Simplicity of control configuration thanks to the supplied RF remote control.
- Can be integrated into a residential home automation network
- Mechanical by-pass for natural ventilation (free-cooling) on summer evenings.



# VORT PROMETEO PLUS HR 400 RANGE

Heat recovery units

## TECHNICAL DATA

MODEL	CODE	V~50HZ	W max	A max	MAX AIRFLOW m <sup>3</sup> /h	l/s	MAX PRESSURE mmH <sub>2</sub> O	Pa	°C* MAX	Kg
VORT PROMETEO PLUS HR 400	11582	230	160	1.3	380	106	68.8	675	50	25

\* Max operating temperature in continuous conditions

## ENERGY DATA

	Unit of measurement	VORT PROMETEO PLUS HR 400 MP
Supplier's name or trade mark	-	Vortice
Specific Energy Consumption class SEC in average climate zone		A
Specific Energy Consumption class SEC average	kWh/m <sup>2</sup> anno	-38.8
Specific Energy Consumption class SEC cold		-77.3
Specific Energy Consumption class SEC warm	-	-14.2
Declared typology	-	UVR-B**
Type of drive	-	VSD***
Type of heat recovery system HRS	-	recuperative
Thermal efficiency of heat recovery at HRS reference air flow	%	88.3
Maximum flow rate [m <sup>3</sup> /s]	m <sup>3</sup> /h	340
Electric power input of the fan drive, including any motor control equipment, at maximum flow rate	W	161.0
Sound power level LWA	LWA [DB(A)]	62
Reference flow rate	m <sup>3</sup> /s	0.0661
Reference pressure difference	Pa	240
SPI****	W/(m <sup>3</sup> /h)	0.28992
Control factor CTRL	-	0.85
Control typology	%	central demand control
Maximum internal leakage rates	%	1.2
Maximum external leakage rates	-	3.2
Mixing rate	-	NA*
Position and description of visual filter warning	-	see user manual
Airflow sensitivity to pressure variations at ± 20 PA	m <sup>3</sup> /h	NA*
Indoor/outdoor air tightness	-	NA*
Annual electricity consumption (AEC)	kWh electricity/year	307
AHS average Annual heating saved		4584
AHS cold Annual heating saved	kWh primary energy/year	8967
AHS warm Annual heating saved		2073

Energy data pursuant to 1254/2014 EU Regulation

\* NA: Data not applicable

\*\* UVR-B: Bidirectional Residential Ventilation Unit.

\*\*\* VSD: Variable Speed Drive.

\*\*\*\* SPI: Specific Power Input



**DIMENSIONS**

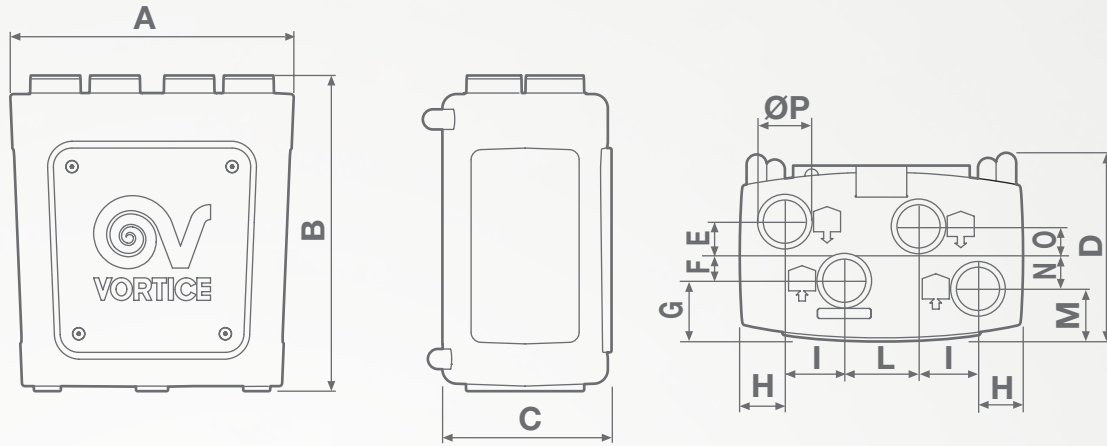

MODE	A	B	C	D	E	F	G	H	I	L	M	N	O	ØP
VORT PROMETEO PLUS HR 400	840	935	502	560	85	100	156.7	133.6	176	220	180.7	76	99	150

Quote in mm

**SOUND LEVELS**

RPM		Sound Power							Sound Power Tot.	Pressure Power Tot.
		125 Hz	250 Hz	500 Hz	1000 Hz	2000 Hz	4000 Hz	8000 Hz	Lw dB(A)	Lp dB(A)* 3m
700	Inlet	8.4	9.3	14.0	22.6	5.0	9.2	10.1	28.0	7.5
	Outlet	5.7	15.0	18.1	16.4	13.9	12.2	7.5	27.5	7.0
	Radiated	14.3	39.2	18.3	20.6	2.9	7.1	nd**	44.0	23.5
1600	Inlet	18.5	24.1	29.4	37.5	24.8	15.6	13.3	43.2	22.7
	Outlet	16.0	25.6	27.9	28.4	18.8	6.8	3.3	37.6	17.1
	Radiated	21.7	31.9	38.3	34.0	23.8	11.8	7.5	48.4	27.9
2100	Inlet	16.9	32.3	36.6	48.3	35.8	24.7	10.2	56.7	36.2
	Outlet	14.9	34.7	32.8	38.4	29.2	15.7	nd**	46.4	25.9
	Radiated	24.6	41.1	41.6	47.1	34.8	20.8	5.6	58.0	37.5
2650	Inlet	20.3	40.9	46.0	64.7	41.8	33.7	18.5	65.5	45.0
	Outlet	19.1	42.5	38.4	60.0	36.0	25.6	13.8	60.7	40.2
	Radiated	31.3	43.0	48.1	59.2	41.4	29.1	13.6	61.3	40.8
3000	Inlet	23.5	41.3	47.5	52.0	44.1	37.1	22.8	59.4	38.9
	Outlet	19.7	42.7	40.6	43.2	38.0	27.1	12.2	53.6	33.1
	Radiated	28.9	45.7	47.9	47.4	43.9	33.3	16.2	59.5	39.0
3350	Inlet	25.3	44.4	49.7	54.8	48.4	42.3	28.8	62.7	42.2
	Outlet	23.6	43.4	43.2	45.7	41.5	31.6	13.5	55.5	35.0
	Radiated	31.8	46.7	51.5	55.2	47.5	37.4	22.0	62.4	41.9

\* Tests carried out using sound intensity measurement in a semi-anechoic chamber.



# VORT PROMETEO PLUS HR 400 RANGE

Heat recovery units

## PERFORMANCE CURVES

### POWER CONSUMPTION CURVES

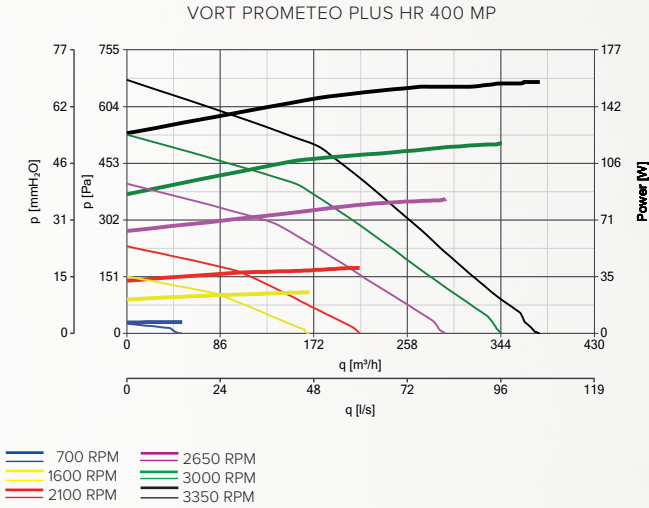

### Efficiency as a function of the airflow

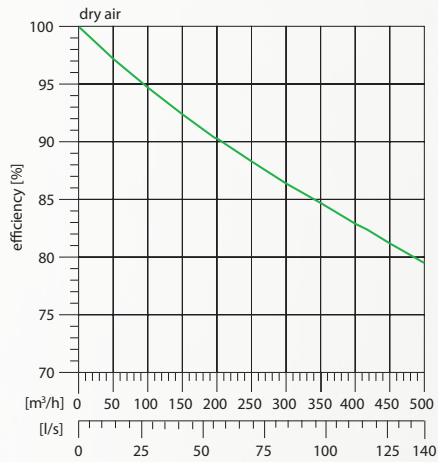

TEST RESULTS  
(tests according to EN 308 standards)

TOTAL EXHAUST FLOW RATE (m <sup>3</sup> /h)	HEAT RECOVERY EFFICIENCY (%)
54	93
76	91
98	90
119	89
140	89
162	88
184	88
205	87

Test conditions: +5°C/70%; +25°C/28%.

### Influence on efficiency due to condensation heat

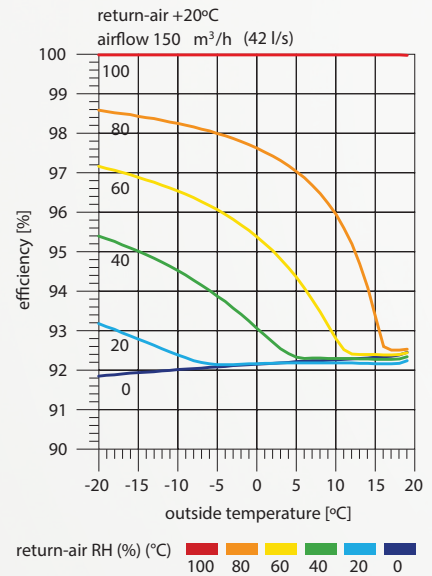

## ACCESSORIES



RF - code 22464  
Remote Controller White



code 22469  
Electric Heater 1800



code 22479  
External RF Module HR 400  
PLUS



code 22478  
Three speed  
selector switch 400 M



code 22342  
F5 Filter  
for external filter box



code 22343  
Vort Plenum 6+1



code 22347  
Vort Plenum 5+1 AR



code 22329  
F5 External Filter Box

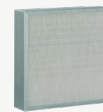

code 22321  
F5 FILTER



code 22323  
F7 FILTER



code 22316  
Flexible silencer 150  
(500 mm)



code 22318  
Heat Exchanger

code 22340  
Hexagonal Screwdriver for  
Maintenance

code 22751  
Flexible silencer  
150 (1000 mm)



code 22756  
Rigid Silencer NA 150  
(noise attenuator)



# VORT HR 300 NETI NEW

Wall-mounted heat recovery systems

A

Dual flow centralised unit with heat recovery for floor and wall installation. Ideal for ventilation of homes and residential and commercial premises with surface area up to 180 m<sup>2</sup>.

- 1 model.
- Casings in fire-resistant expanded polypropylene (DIN EN 13501). Brackets for wall-installation included in standard supply.
- Front plastic resin panels incorporating the panels for direct access to the filters.
- Extraction and delivery spigots compatible with pipes having nominal diameter equal to 125 mm.
- Pair of electric fans driven by external rotor EC motors (brushless) with shafts mounted on ball bearings to ensure virtually "maintenance-free" operation, directly coupled to backward-curved centrifugal impellers for high aerodynamic efficiency. 3 operating speeds, can be set independently on installation.
- High efficiency counter cross flow heat exchanger, made in plastic resin (PS).
- Automatically activated anti-freeze protection to prevent the formation of frost at the heat exchanger.
- Mechanical by-pass, automatic and 100% filtered to guarantee the comfort of the occupants of the rooms in mid-season, or however when the outdoor temperature does not require the action of the heat exchanger.
- Wired remote control unit supplied as per standard, with LCD for:
  - product switch-on and switch-off;
  - the initial configuration of the product;
  - selection of operating speed;
  - programming operation;
  - display of the time and room temperature,
  - monitoring of the correct operation of the product (any malfunctioning is highlighted through error messages shown on the display);
  - indication of the condition of the saturated filters on the display.
- Pair of filters (1 x M5 outdoor air filter +1 x G4 expulsion filter), easily accessible for cleaning and replacement to guarantee the quality of the air introduced into the rooms and for protection of the internal components.
- Connections to piping positioned on the upper part of the product for easy installation on the floor or wall.
- Small dimensions (600x812x317mm) to guarantee easy installation, configuration and use.
- Performance and safety certified by third party body (CE).
- Protection rating from dusts and water: IPX2.
- Class of electric isolation: II (earthing not required).





## KEY FEATURES

---

- High (up to 92,5%) heat exchange efficiency.
- High performance, suitable for correct ventilation of small and medium sized apartments and villas.
- Wired remote control unit with LCD.
- Mechanical by-pass, 100% filtered, for natural ventilation (free-cooling) on summer evenings.



# VORT HR 300 NETI NEW

Wall-mounted heat recovery systems

## TECHNICAL DATA

MODELS	CODE	V~50HZ	W max	A max	MAX FLOW RATE		MAX PRESSURE		°C* MAX	Kg
					m³/h	l/s	mmH <sub>2</sub> O	Pa		
VORT HR 300 NETI	10935	220-240	190	1,35	300	83	75	735	40	15

\* Product continuous operation maximum temperature.

## ENERGY DATA

	Unit of measurement	VORT HR 300 NETI 10935
Manufacturer's name or brand name	-	Vortice
Specific energy consumption class for temperate climate	-	A
Specific energy consumption sec (temperate climate)	kWh/m <sup>2</sup> year	- 35
Specific energy consumption sec (cold climate)		- 74
Specific energy consumption sec (hot climate)		- 11
Type of ventilation unit declared	-	UVR-B**
Type of drive	-	VSD***
Type of heat exchanger system HRS	-	with recovery
Heat efficiency of heat recovery at the reference flow rate HRS	%	87,9
Maximum flow rate	m³/h	270
Total electric power absorbed by the fan at maximum flow rate	W	190
Sound power level	LWA [DB(A)]	57,2
Reference flow rate	m³/s	0.0525
Reference pressure difference	Pa	56
SFI****	W/(m³/h)	0.4392
Control factor CTRL	-	0.85
Type of control	-	centralised env.
Maximum percentage of internal leakage	%	2,8
Maximum percentage of external leakage	%	2,3
Rate of mixture	-	NA*
Position and description of the filters visual signal	-	See user manual
Sensitivity of the air flow to pressure changes at ± 20 PA	-	0.27
Internal/external air sealing	m³/h	NA*
AEC annual consumption of electricity	kWh of electricity/year	442
AHS annual heating saved with temperate climate	kWh of primary energy/year	4573
AHS annual heating saved with cold climate		8946
AHS annual heating saved with hot climate		2068

Energy data pursuant to 1254/2014 EU Regulation

\* NA: Not Applicable.

\*\* UVR-B: Residential Ventilation Unit - Bidirectional.

\*\*\* VM: Multiple Speed. VSD: Variable Speed Drive.

\*\*\*\* SFI: Power absorbed power.

**DIMENSIONS**

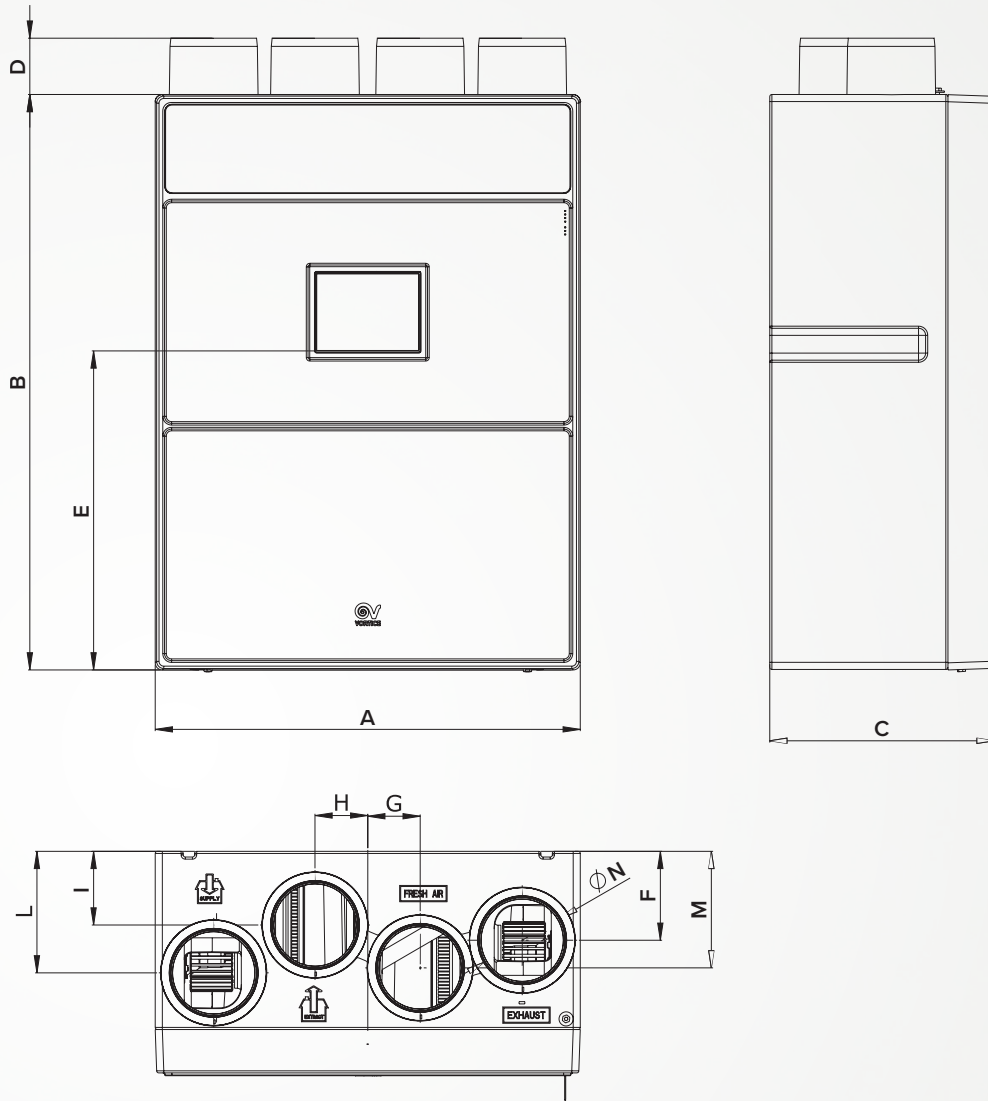

MODELS	A	B	C	D	E	F	G	H	I	L	M	$\varnothing N$
VORT HR 300 NETI	600	812	317	80	450	125	74	74	104	172	165	125

Dimensions in mm



# VORT HR 300 NETI NEW

Wall-mounted heat recovery systems

## PERFORMANCE CURVES

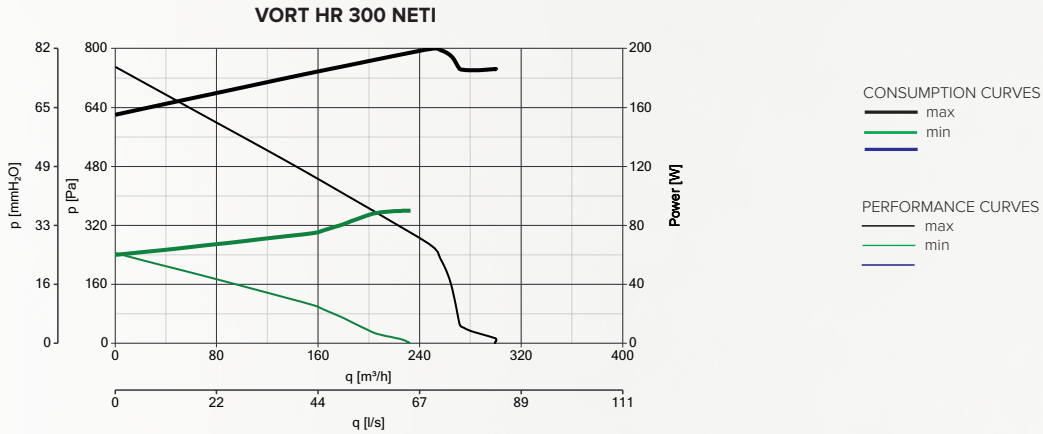

Efficiency as a function of the airflow

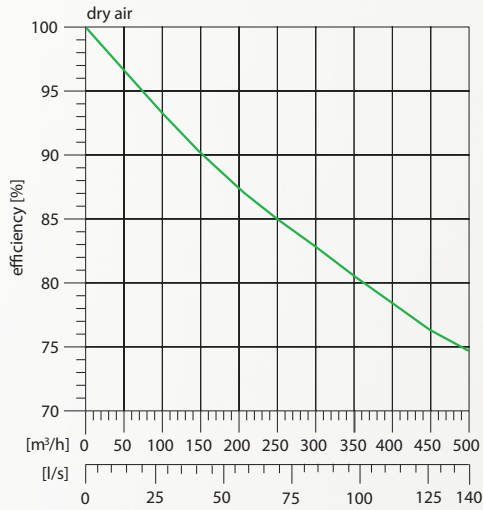

Influence on efficiency due to condensation heat

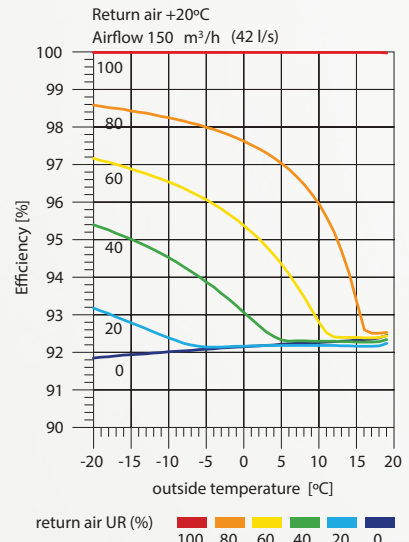

ACCESSORIES



Electric heater HRI 200 PHANTOM - code 22734



Electric heater 500- code 22467  
Electric heater 1200 - code 22468



G4 filter for VORT HR NETI - code 21116

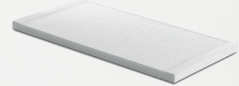

M5 filter for VORT HR NETI - code 21117

Electric heater HRI 350 PHANTOM - code 22735

Electric heater 1800 - code 22469

LCD CONTROL PANEL FULL VERSIONS

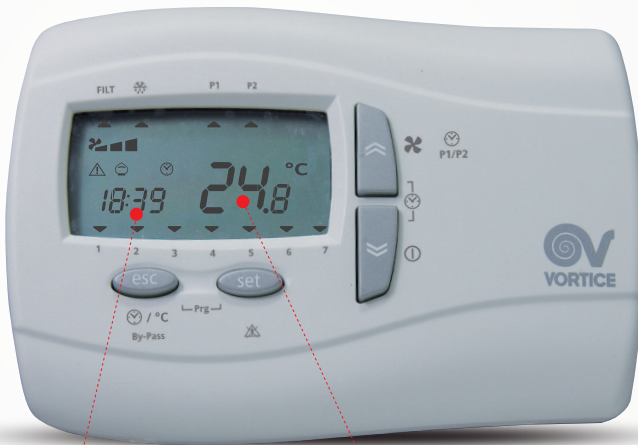

TIMER

TEMPERATURE

Icons

Functions

	No-Frost
<b>P1 - P2</b>	Programs profile
	Speeds
	OFF
	Allarms
	By-pass
	Time/Programmable timetable
<b>FILT</b>	Filter warning
<b>HA</b>	Antibacterial function

- To switch the machine on/off.
- To select one of the 3 speed settings.
- Selecting the By-pass function.
- Programmable timetable setting.
- Set point environmental temperature.
- Warnings display.
- Time or external temperature display.



# VORT HR 350 AVEL

NEW

Wall-mounted heat recovery systems

A

Dual flow centralised unit with heat recovery for floor and wall installation. Ideal for ventilation of homes and residential and commercial premises with surface areas up to 240 m<sup>2</sup>.

- 1 model.
- Casings in fire-resistant expanded polypropylene (DIN EN 13501). Brackets for wall-installation included in standard supply.
- Front plastic resin panels incorporating the panels for direct access to the filters.
- Extraction and delivery spigots compatible with pipes having nominal diameter equal to 150 mm.
- Pair of electric fans driven by external rotor EC motors (brushless) with shafts mounted on ball bearings to ensure virtually "maintenance-free" operation, directly coupled to backward-curved centrifugal impellers for high aeraulic efficiency. 2 operating speeds, can be set independently on installation.
- High efficiency counter cross flow heat exchanger, made in plastic resin (PS).
- Automatically activated anti-freeze protection to prevent the formation of frost at the heat exchanger.
- Mechanical by-pass, automatic and 100% filtered to guarantee the comfort of the occupants of the rooms in mid-season, or however when the outdoor temperature does not require the action of the heat exchanger.
- Wired remote control unit supplied as per standard, with LCD for:
  - product switch-on and switch-off;
  - the initial configuration of the product;
  - selection of operating speed;
  - programming operation;
  - display of the time and room temperature,
  - monitoring of the correct operation of the product (any malfunctioning is highlighted through error messages shown on the display);
  - indication of the condition of the saturated filters on the display.
- Pair of M5 filters (F7 filter available as an optional for the delivery duct), easily accessible for periodic maintenance interventions.
- Condensate collection tray with drain devices.
- Possibility of interlocking to outdoor environmental sensors (optionals) for automatic control of the operating mode.
- Safety certified by third party body (CE).
- Protection rating from dusts and water: IPX2.
- Class of electric isolation: I (earthing not required).

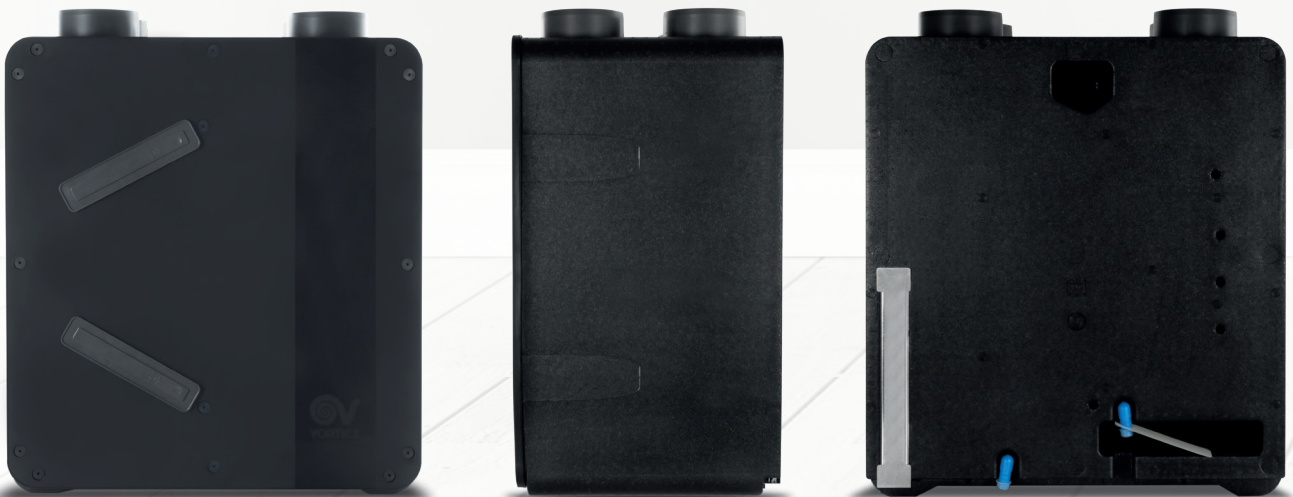



## KEY FEATURES

---

- High (up to 92%) heat exchange efficiency.
- High performance, suitable for the correct ventilation of large apartments and villas.
- Wired remote control unit with LCD.
- Mechanical by-pass, 100% filtered, for natural ventilation (free-cooling) on summer evenings.



# VORT HR 350 AVEL

NEW

Wall-mounted heat recovery systems

## TECHNICAL DATA

MODELS	CODE	V ~ 50 Hz	W	A	MAX AIRFLOW		MAX PRESSURE		°C* max	Kg
					m³/h	l/s	mmH <sub>2</sub> O	Pa		
VORT HR 350 AVEL	12106	230	165	1.4	350	100	90	880	40	22

\* Product continuous operation maximum temperature.

## ENERGY DATA

	Code	Unit of measurement	VORT HR 350 AVEL
			12106
Supplier's name or trade mark		-	Vortice
Specific Energy Consumption class SEC in average climate zone		-	A
Specific Energy Consumption class SEC average			-38,4
Specific Energy Consumption class SEC cold		kWh/m <sup>2</sup> year	-77,0
Specific Energy Consumption class SEC warm			-13,6
Declared typology		-	BRVU*
Type of drive		-	VSD**
Type of heat recovery system HRS		-	recuperative
Thermal efficiency of heat recovery at reference air flow		%	88,9
Maximum flow rate [m³/s]		m³/h	315
Electric power input of the fan drive, including any motor control equipment, at maximum flow rate		W	170,0
Sound power level LWA		LWA [dB(A)]	57
Reference flow rate		m³/s	0,0613
Reference pressure difference		Pa	70
SPI***		W/(m³/h)	0,31746
Control factor CTRL		-	0,85
Control typology		-	central demand control
Maximum internal leakage rates		%	3,4
Maximum external leakage rates		%	3,3
Mixing rate		-	NA*
Position and description of visual filter warning		-	see user manual
Airflow sensitivity to pressure variations at + 20Pa and - 20 Pa		-	NA*
Indoor/outdoor air tightness		m³/h	NA*
Annual electricity consumption (AEC)		kWh electricity/year	332
AHS average Annual heating saved			4600
AHS cold Annual heating saved		kWh primary energy/year	8999
AHS warm Annual heating saved			2080

\*BRVU: Bidirectional Residential Ventilation Unit  
 \*URVU: Unidirectional Residential Ventilation Unit

\*\*VSD: Variable Speed Drive  
 \*\*MSD: Multi Speed Drive

\*\*\*SPI: Specific Power Input

NA: data not applicable





**DIMENSIONS**

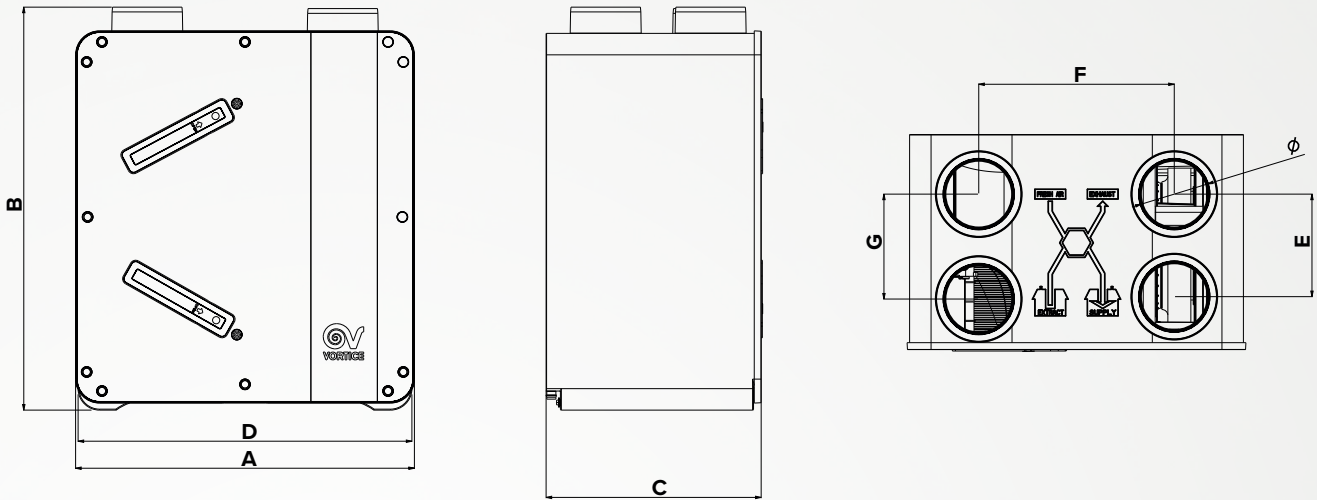

MODELS	CODE	A	B	C	$\emptyset$	D	E	F	G
VORT HR 350 AVEL	12106	712	845	455	150	700	215	410	220

Dimensions (mm)

**SOUND LEVELS**

		Sound Power							Sound Power Tot.	Sound Pressure Tot.
		Lw dB (A)								
		125 Hz	250 Hz	500 Hz	1000 Hz	2000 Hz	4000 Hz	8000 Hz	Lw dB (A)	Lp dB (A)*
Min. Speed	Supply to internal	23.6	26.7	30.1	26.6	25.4	13.9	5.3	39.4	18.9
	Extract to internal	17.4	26.9	28.1	32.8	35.3	26.5	21.8	43.0	22.5
	Breakout	3.0	10.6	19.9	20.4	13.9	3.5	1.2	28.1	7.6
Med. Speed	Supply to internal	30.2	42.4	39.7	36.1	36.3	28.1	19.2	49.0	28.5
	Extract to internal	15.5	40.3	43.6	41.5	45.8	37.2	37.5	53.0	32.5
	Breakout	1.7	24.4	28.2	28.8	24.1	12.2	9.6	36.6	16.1
Max. Speed	Supply to internal	35.3	42.0	43.8	43.1	43.1	36.5	30.7	57.3	36.8
	Extract to internal	17.8	37.8	43.9	48.1	53.0	45.8	48.6	60.2	39.7
	Breakout	8.7	23.7	33.4	34.5	31.6	21.3	20.6	43.6	23.1

\* Sound pressure calculated at 3 m in free field conditions in compliance with the ISO 9614 Standard.



# VORT HR 350 AVEL

NEW

Wall-mounted heat recovery systems

## PERFORMANCE CURVES

VORT HR 350 AVEL

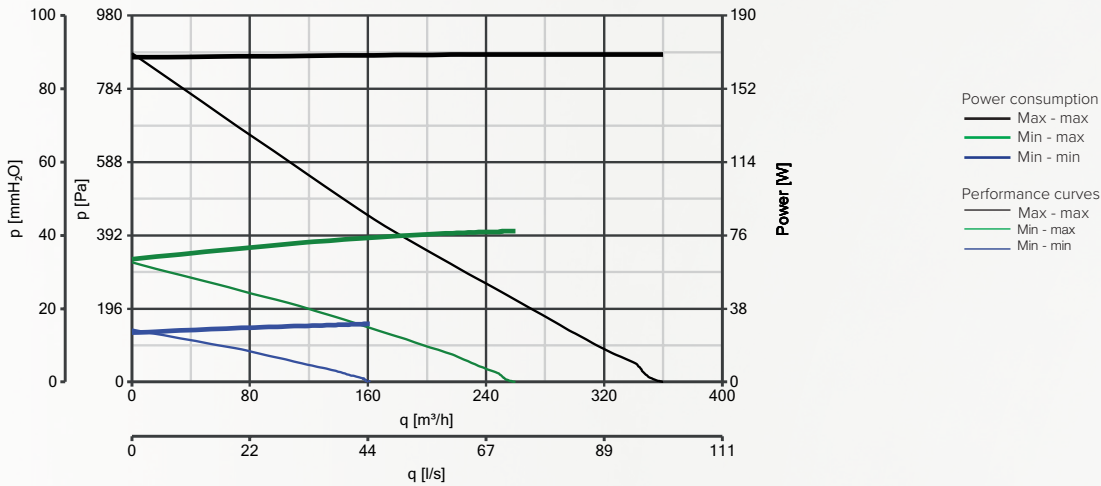

Efficiency as a function of the airflow

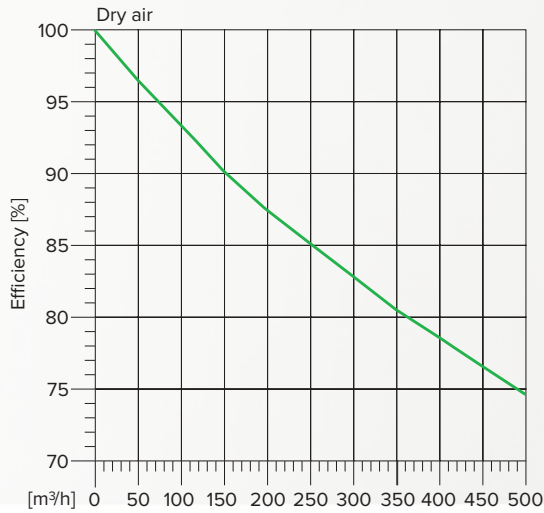

Influence on efficiency due to condensation heat

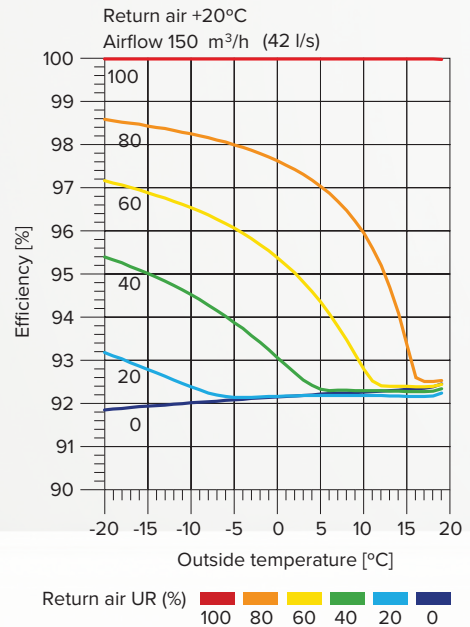

**ACCESSORIES**

---



Electric heater 750 W - code 22735

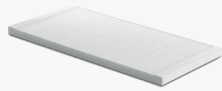

G3 (Filter for Avel) - code 22661

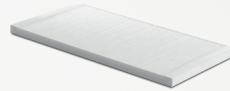

M5 (Filter for Avel) - code 22662



Floor fixing kit - code 22663

F7 (Filter for VORT HR AVEL)  
- code 22664**CONTROLS**

---

C TEMP - code 12992  
Temperature sensorC HCS - code 12994  
Humidity sensorC SMOKE - code 12993  
Temperature sensorC PIR - code 12998  
Motion sensor



# VORT HR 350 EXO RANGE

Wall-mounted residential heat recovery unit

A+

Dual flow centralised unit with heat recovery for floor and wall installation ideal for ventilation of homes and residential and commercial premises.

- Enclosure in galvanised steel sheet insulated by fire-resistant (DIN EN 13501), sound-proof lining.
- Ports nominal diameter 150 mm.
- Very high-efficiency counter-flow heat exchanger in PS resin.
- Highly efficient backward curved centrifugal fans moved by EC (brushless) 3 speed motors impellers with backward-curved blades.
- 2 easily accessible F5 filters (optional F7 filter on intake).
- Integrated frost protection.
- Wired electronic control allowing with LCD display:
  - initial configuration;
  - manual setting of operating mode;
  - automatic operation according to ambient conditions detected by wired sensor (optional);
  - continuous monitoring of correct operation (possible problems shown on LCD display);
  - constant monitoring of filter status (maintenance needs shown on LCD display);
  - SW updating through dedicated port.
- Blocked filter status monitoring system.
- Support brackets for wall-mounting.
- Protection rating: IPX2.
- Insulation class: I. ⊕ .

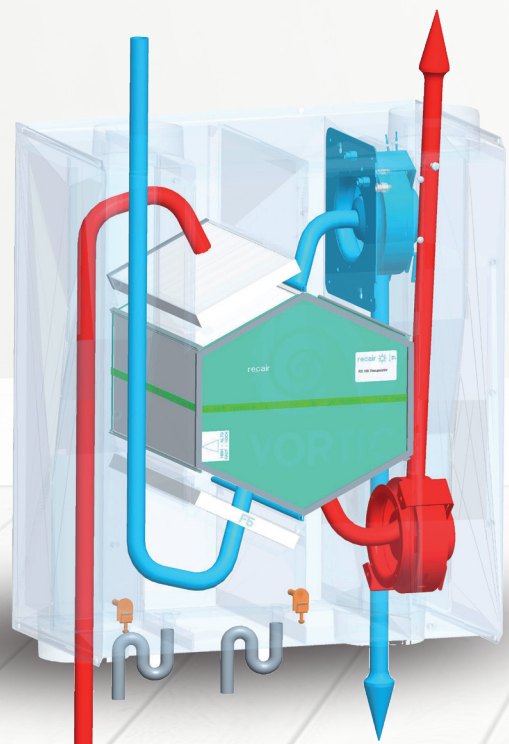
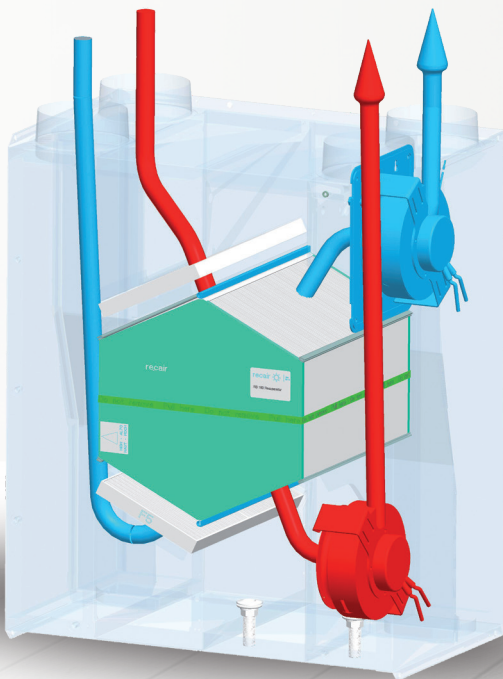



## KEY FEATURES

- Designed for outdoor installation.
- High performances (350 m<sup>3</sup>/h) combined with low power consumption. (150 W).
- Very high-heat transfer efficiency (Max 92%) in the conditions (+5°C, +25°C, 28% RH) established by applicable international standards (EN 308).
- Proportionately compact dimensions
- 2 versions: 4 parts on the top or split on the top and the bottom to accomplish different installations.
- Painted sheet steel cabinet (optional), to house the product in outdoor areas in the absence of dedicated closed vanes.
- Painted sheet steel heated cabinet (optional), designed to ensure the correct and effective operation of the appliance outdoor, even at low temperatures.



# VORT HR 350 EXO RANGE

Wall-mounted residential heat recovery unit

## TECHNICAL DATA

MODELS	CODE	V ~ 50 Hz	W	A	MAX AIRFLOW		MAX PRESSURE		°C max	Kg
					m³/h	l/s	mmH <sub>2</sub> O	Pa		
VORT HR 350 EXO	11590	230	140	1.2	350	97.2	40	392	50	38w

## ENERGY DATA

	Code	Unit of measurement	VORT HR 350 EXO 11590
Supplier's name or trade mark		-	Vortice
Specific Energy Consumption class SEC in average climate zone		-	A+
Specific Energy Consumption class SEC average			-42,3
Specific Energy Consumption class SEC cold		kWh/m <sup>2</sup> year	-81,2
Specific Energy Consumption class SEC warm			-17,4
Declared typology		-	BRVU*
Type of drive		-	VSD**
Type of heat recovery system HRS		-	recuperative
Thermal efficiency of heat recovery at reference air flow		%	89,9
Maximum flow rate [m³/s]		m³/h	284
Electric power input of the fan drive, including any motor control equipment, at maximum flow rate		W	66,0
Sound power level LWA		LWA [dB(A)]	57
Reference flow rate		m³/s	0,0556
Reference pressure difference		Pa	50
SPI***		W/(m³/h)	0,15500
Control factor CTRL		-	0,85
Control typology		-	local demand control
Maximum internal leakage rates		%	15,5
Maximum external leakage rates		%	8,2
Mixing rate		-	NA*
Position and description of visual filter warning		-	See user manual
Airflow sensitivity to pressure variations at + 20Pa and - 20 Pa		-	NA*
Indoor/outdoor air tightness		m³/h	NA*
Annual electricity consumption (AEC)		kWh electricity/year	185
AHS average Annual heating saved			4627
AHS cold Annual heating saved		kWh primary energy/year	9052
AHS warm Annual heating saved			2092

Energy data pursuant to 1254/2014 EU Regulation

\*BRVU: Bidirectional Residential Ventilation Unit  
\*URVU: Unidirectional Residential Ventilation Unit

\*\*VSD: Variable Speed Drive  
\*\*MSD: Multi Speed Drive

\*\*\*SPI: Specific Power Input

NA: data not applicable

**DIMENSIONS**

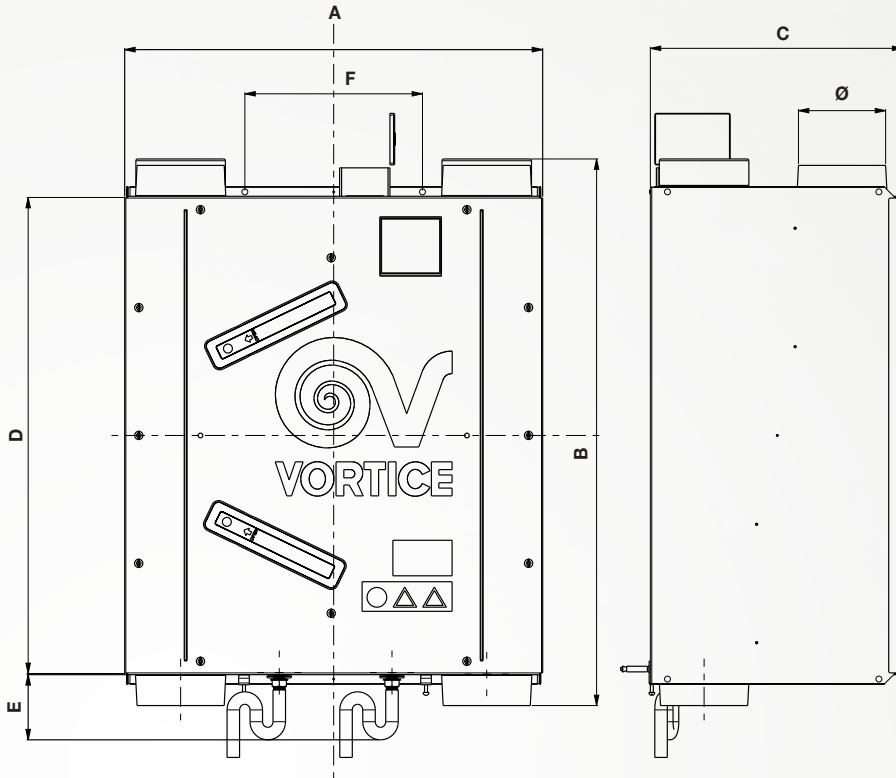

MODELS	CODE	A	B	C	D	E	F	Ø
VORT HR 350 EXO	11590	706	923	429	804	100	300	150

Dimensions (mm)

**SOUND LEVELS**

		Sound Power						Sound Power Tot.	Sound Pressure Tot.	
		Lw dB (A)						Lw dB (A)	Lp dB (A)**	
		125 Hz	250 Hz	500 Hz	1000 Hz	2000 Hz	4000 Hz			8000 Hz
Nom. Speed	Supply to internal	26.8	36.4	42.8	32.0	26.0	13.3	8.7	53.9	33.4
	Extract to internal	9.8	21.8	18.5	15.5	n.a.	n.a.	n.a.	31.2	10.7
	Breakout	42.5	44.0	43.9	39.6	35.2	26.9	17.2	56.5	36

Tests carried out according EN9614 standard. \*\*Sound pressure calculated at 3 m distance in free-field.  
n.a. = data not available



# VORT HR 350 EXO RANGE

Wall-mounted residential heat recovery unit

## PERFORMANCE CURVES

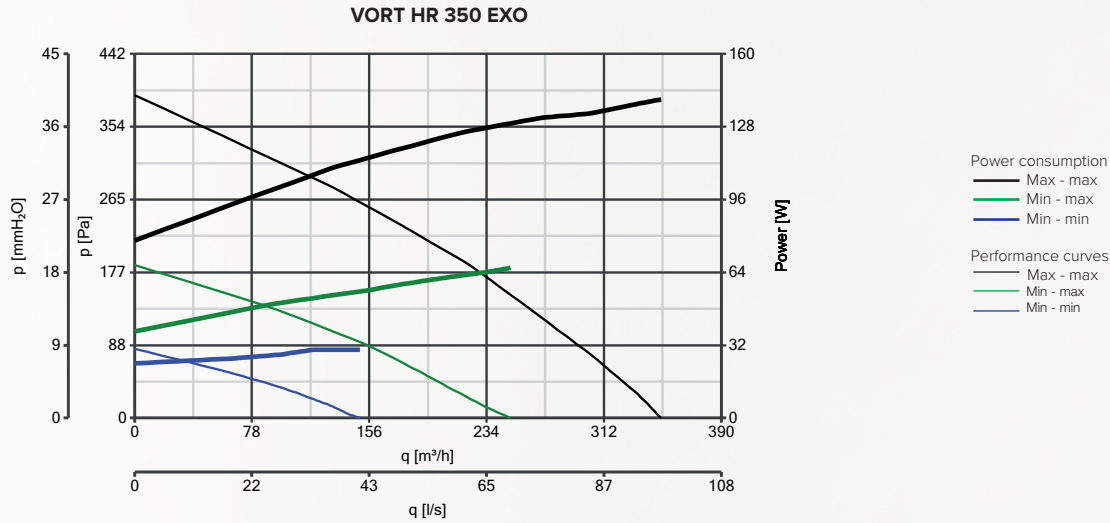

Efficiency as a function of the airflow

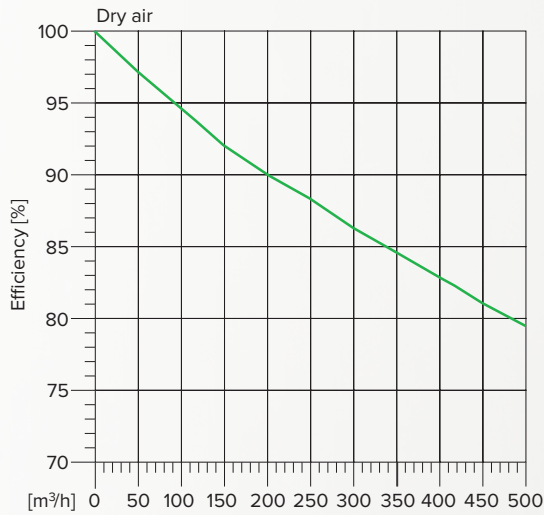

Influence on efficiency due to condensation heat

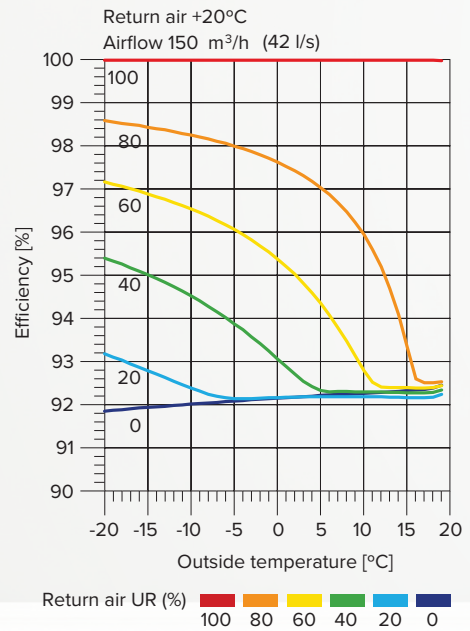



## ACCESSORIES

---



code 22323  
F7 filter



# VORT HRI DH RANGE

Ceiling-mounted heat recovery units with built-in dehumidifier

## A

Centralized double flow ventilation unit with heat recovery unit for false-ceiling installation, provided with a direct expansion chiller circuit, designed for ventilation and dehumidification of residential and commercial premises up to 120 m<sup>2</sup> (VORT HRI 260 DH) and 240 m<sup>2</sup> (VORT HRI 500 DH), in conjunction with radiant cooling systems.

- 2 models:  
VORT HRI 260 DH; VORT HRI 500 DH.
- 2 versions:  
DH (equipped with electronic temperature relative humidity probe);  
DH RC (compatible with mechanical wired thermo-humidistat)
- Enclosures made of galvanized steel sheet removable panels to facilitate inspection and maintenance.
- Reciprocating or rotary compressors, operating with R 134A and R 410A respectively, according to model.
- Double water/air condenser.
- Very high-efficiency counter-flow heat exchanger in PS resin.
- Highly-efficient centrifugal fans moved by EC motors (brushless); a speeds can be set by means of trimmers according to the system pressure drops.
- Flow meter.
- Three-way modulating valve.
- 3 G4 filters.
- Motor-operated recirculation damper.
- Electronic control unit with microprocessor, including LCD display for:
  - Monitoring the refrigeration circuit;
  - Integrated management of aeraulic and hydronic sections;
  - Summer/winter operating mode switching;
  - Integrated frost protection;
  - Diagnostics for possible malfunctions
  - Supervision via RS485 serial port and/or Internet (optional)
  - Filter monitoring (optional).
- Wired mechanical thermo-humidistat for Mod. DH RC (optional).
- Built-in electronic "temperature - relative humidity sensor" (mandatory for Mod. DH)
- Remote control panel (optional).
- H10 electrostatic filter (optional).
- Tie-rods for suspended installation.
- Protection rating: IPX2.
- Insulation class: I. Ⓡ



## KEY FEATURES

- Compact size, to facilitate installation in false ceilings.
- All-in-one architecture, for effective operation and easy installation.
- Possibility of implementing the dehumidifying function by making direct use of the water from the radiant cooling system.
- 3 operating models: Summer (compressor ON);
- Renewal + dehumidification with neutral air (compressor on) dehumidified air is introduced into the room at the same temperature; Winter (compressor OFF)
- In winter mode coil can be supplied with water taken from the radiant heating system.
- Built-in electronic temperature-humidity sensor (optional).



# VORT HRI DH RANGE

Ceiling-mounted heat recovery units with built-in dehumidifier

## TECHNICAL DATA

MODELS	VORT HRI 260 DH code 45091	VORT HRI 260 DH RC code 45092	VORT HRI 500 DH code 45093	VORT HRI 500 DH RC code 45094
Supply	230 V /50 Hz	230 V /50 Hz	230 V /50 Hz	230 V /50 Hz
Absorbed Power of air supply fan (min/nom/max) (W)	10-30-86	10-30-86	30-60-130	30-60-130
Absorbed Power of extractor fan (min/nom/max) (W)	11-22-43	11-22-43	22-44-68	22-44-68
Total cooling capacity indoor (W)	1380	1380	2820	2820
Nominal absorbed power of compressor (W)	340	340	480	480
Thermal power recovery in winter (W)	950	950	1850	1850
Refrigerant Type	R134A	R134A	R134A	R134A
Dehumidification Capacity (l/24 hr)	30.1	30.1	61.8	61.8
Nominal efficiency of HRU in summer (%)	70	70	70	70
Nominal efficiency of HRU in winter (%)	90	90	90	90
Pressure drops of hydraulic circuit (nom) (kPa)	38	38	35	35
Battery Water flow (min/nom/max) (l/h)	150-250-400	150-250-400	200-350-600	200-350-600
Delivery in summer mode (m <sup>3</sup> /h)	260	260	500	500
Delivery in winter mode (m <sup>3</sup> /h)	0-130	0-130	0-250	0-250
Sound power level Lw [db(a)]	47	47	52	52
Sound Pressure level Lp [dB (A)] 3m	39	39	44	44
Pressure of exhaust fan (Pa) (nom/max) (Pa)	50-140	50-140	50-140	50-140
Pressure of supply fan (Pa) (nom/max) (Pa)	50-140	50-140	50-140	50-140

Kg

60

60

80

80

**DIMENSIONS**

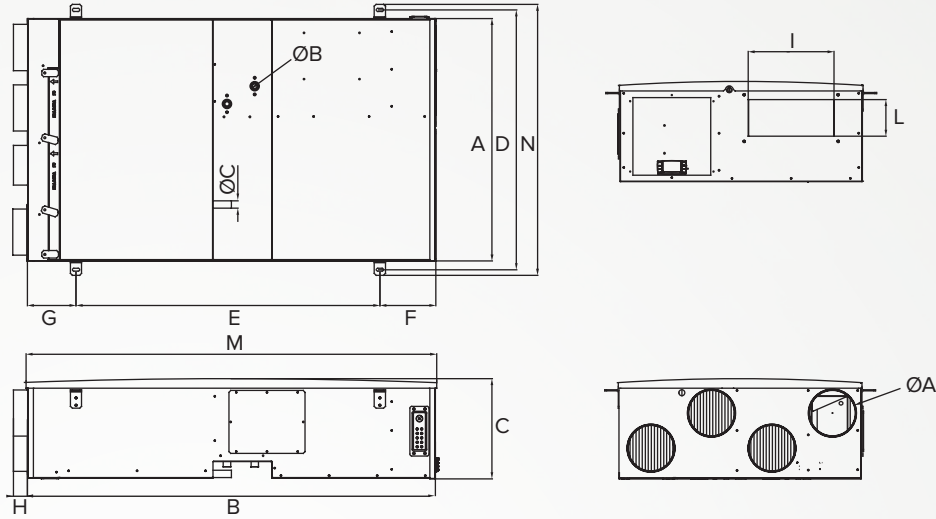

MODELS	CODE	A	B	C	D	E	F	G	H	I	L	M	N	ØA	ØB	ØC
VORT HRI 260 DH	45091	662	1104	280	702	821	152	132	38	232	99	1118	732	125	1/2"	20
VORT HRI 260 DH RC	45092	662	1104	280	702	821	152	132	38	232	99	1118	732	125	1/2"	20

Dimensions (mm)

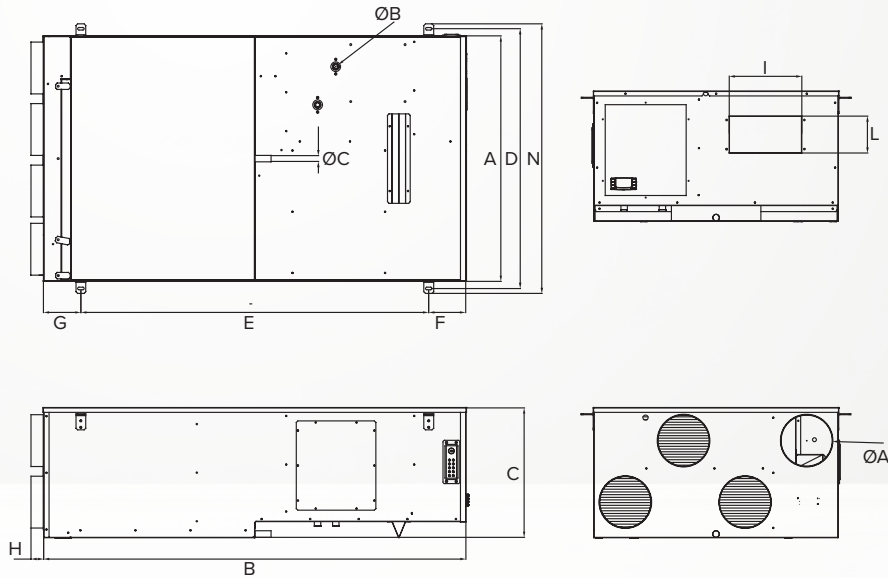

MODELS	CODE	A	B	C	D	E	F	G	H	I	L	N	ØA	ØB	ØC
VORT HRI 500 DH	45093	756	1308	405	802	1074	117	117	38	224	114	832	160	1/2"	20
VORT HRI 500 DH RC	45094	756	1308	405	802	1074	117	117	38	224	114	832	160	1/2"	20

Dimensions (mm)



# VORT HRI DH RANGE

Ceiling-mounted heat recovery units with built-in dehumidifier

## PERFORMANCE CURVES

### PRESSURE DROP IN WATER CIRCUIT

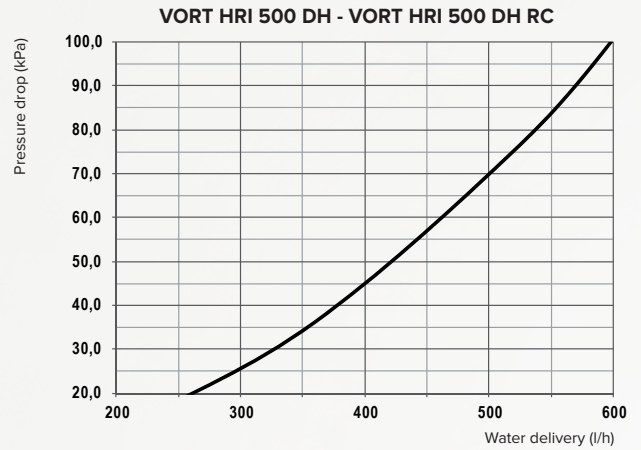
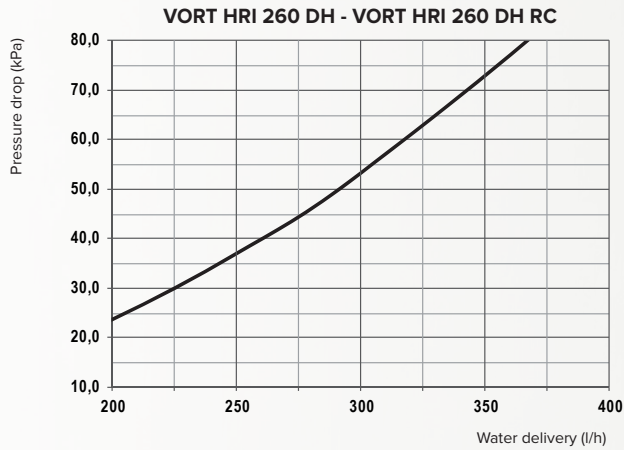

### HEAT RECOVERY UNIT EFFICIENCY

Winter mode: indoor 20°C, 50% RH outdoor: -5°C, 80% RH

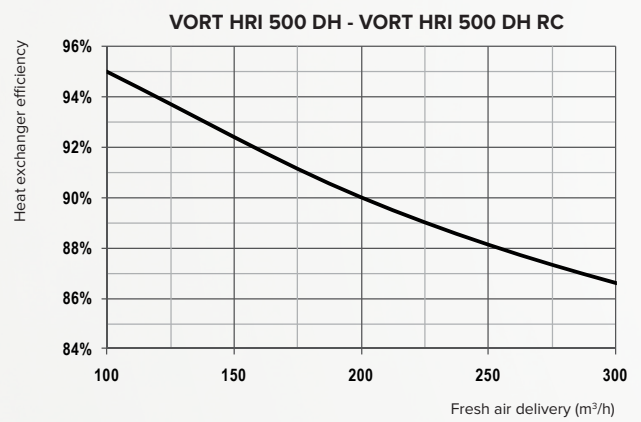
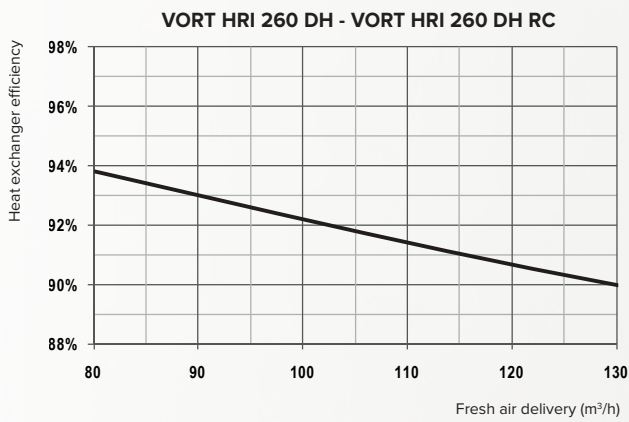

Summer mode: indoor 26°C, 60% RH outdoor: 35°C, 50% RH

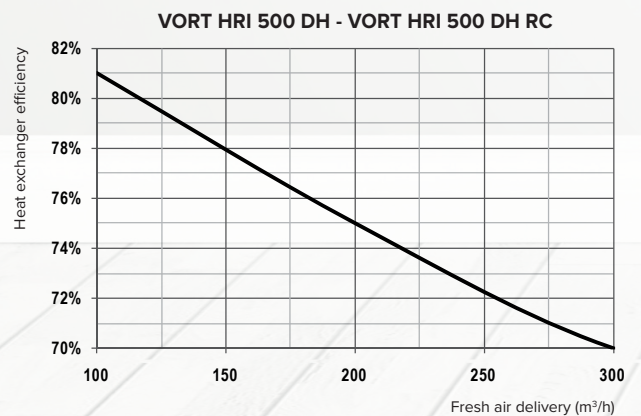
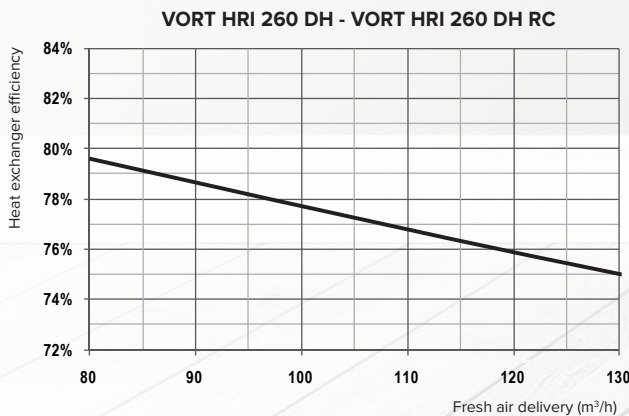



PERFORMANCE CURVES

VORT HRI 260 DH - INLET FAN

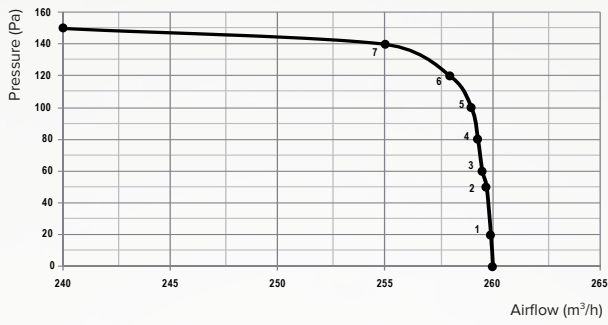

Power	1	2	3	4	5	6	7
260 m³/h	18W	30W	36W	40W	46W	51W	60W

VORT HRI 260 DH - EXTRACT FAN

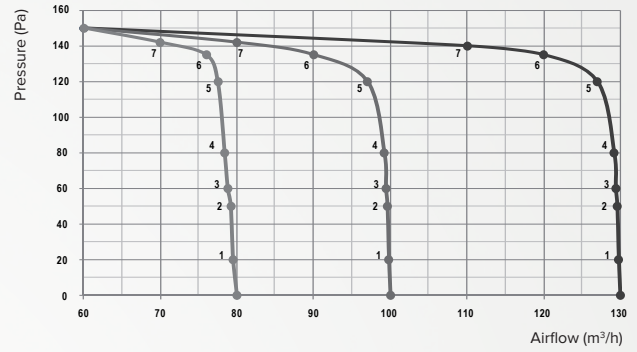

Power	1	2	3	4	5	6	7
80 m³/h	10W	11W	11W	12W	12W	12W	12W
100 m³/h	11W	13W	15W	15W	17W	18W	18W
130 m³/h	11W	13W	15W	19W	22W	30W	34W

VORT HRI 500 DH - INLET FAN

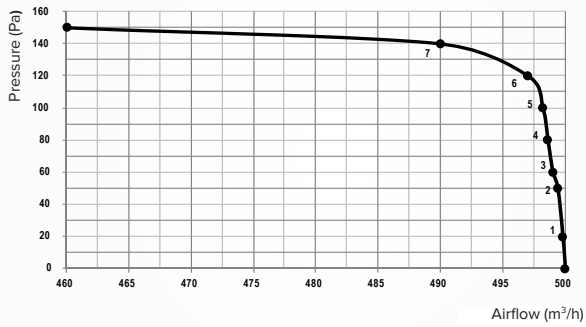

Power	1	2	3	4	5	6	7
500 m³/h	38W	60W	72W	80W	92W	103W	120W

VORT HRI 500 DH - EXTRACT FAN

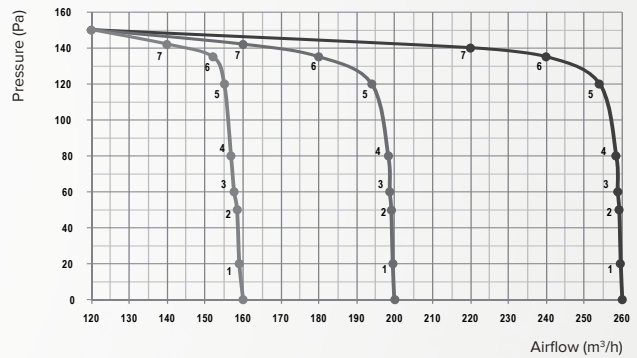

Power	1	2	3	4	5	6	7
160 m³/h	20W	22W	22W	24W	24W	24W	24W
200 m³/h	22W	26W	30W	30W	34W	36W	36W
260 m³/h	22W	26W	30W	38W	44W	60W	68W

ACCESSORIES

ETRH - code 22608 Electronic temp. relative humidity sensor for models 45091 - 45093	RCP - code 22607 Remote control panel for all models	MTRH - code 22609 Mechanical thermal remote humidistat for models 45093 - 45094	code 22653 RS485PCB (HRI DH) for models 45093 - 45094	code 22656 R2T260 (Connection ducts HRI 260 DH (2 x diam. 125 mm) for models 45091 - 45092	code 22657 R2T 500 (HRI DH) for models 45093 - 45094
--------------------------------------------------------------------------------------------	---------------------------------------------------------	---------------------------------------------------------------------------------------	----------------------------------------------------------	-----------------------------------------------------------------------------------------------	---------------------------------------------------------



# VORT HRI PHANTOM RANGE

Ceiling-mounted heat recovery systems

## A

Dual flow, false-ceiling, centralised ventilation unit with heat recovery. Ideal for ventilation of homes and residential and commercial premises measuring up to 90 m<sup>2</sup> (VORT HRI 200 PHANTOM) or 240 m<sup>2</sup> (VORT HRI 350 PHANTOM), characterised by high levels of heat insulation.

- 4 models, different regarding dimensions and performance, equipped with thermodynamic and mechanical by-pass.
- Galvanised steel sheet casings incorporating the support brackets for ceiling-mounting. Body lined with fireproof, sound-proofing and heat insulating material (DIN EN 13501). Tie-rods for suspended installation included in standard supply.
- Lower, thermoformed plastic resin covers incorporating the panels for direct access to the air filters.
- Extraction and delivery spigots compatible with pipes having nominal diameter equal to 125 mm (VORT HRI 200 PHANTOM) and 150 mm (VORT HRI 350 PHANTOM).
- Pair of electric fans driven by external rotor EC motors (brushless) with shafts mounted on ball bearings, directly coupled to backward-curved centrifugal impellers for high aerodynamic efficiency. 3 operating speeds, can be set independently on installation.
- High efficiency counter cross flow heat exchanger, made in plastic resin (PS).
- Automatically activated anti-freeze protection to prevent the formation of frost at the heat exchanger.
- Thermodynamic or mechanical by-pass (BP models), automatic and 100% filtered to guarantee the comfort of the occupants of the rooms in mid-season, or however when the outdoor temperature does not require the action of the heat exchanger.
- Wired remote control unit with LCD supplied as per standard, which allows:
  - product switch-on and switch-off;
  - the initial configuration of the product;
  - the choice of minimum, medium or maximum operating speed;
  - programming operation;
  - display of the time and room temperature,
  - monitoring of the correct operation of the product (any malfunctioning is highlighted through error messages shown on the display);
  - indication of the condition of the saturated filters on the display.
- Pair of M5 filters (F7 filter available as an optional for the delivery duct), easily accessible for periodic maintenance interventions.
- Condensate collection tray with drain devices.
- Possibility of interlocking (BP models) to outdoor environmental sensors (optionals) for automatic control of the operating mode.
- Safety certified by third party body (CE).
- Protection rating from dusts and water: IPX2.
- Class of electric isolation: I (earthing required).

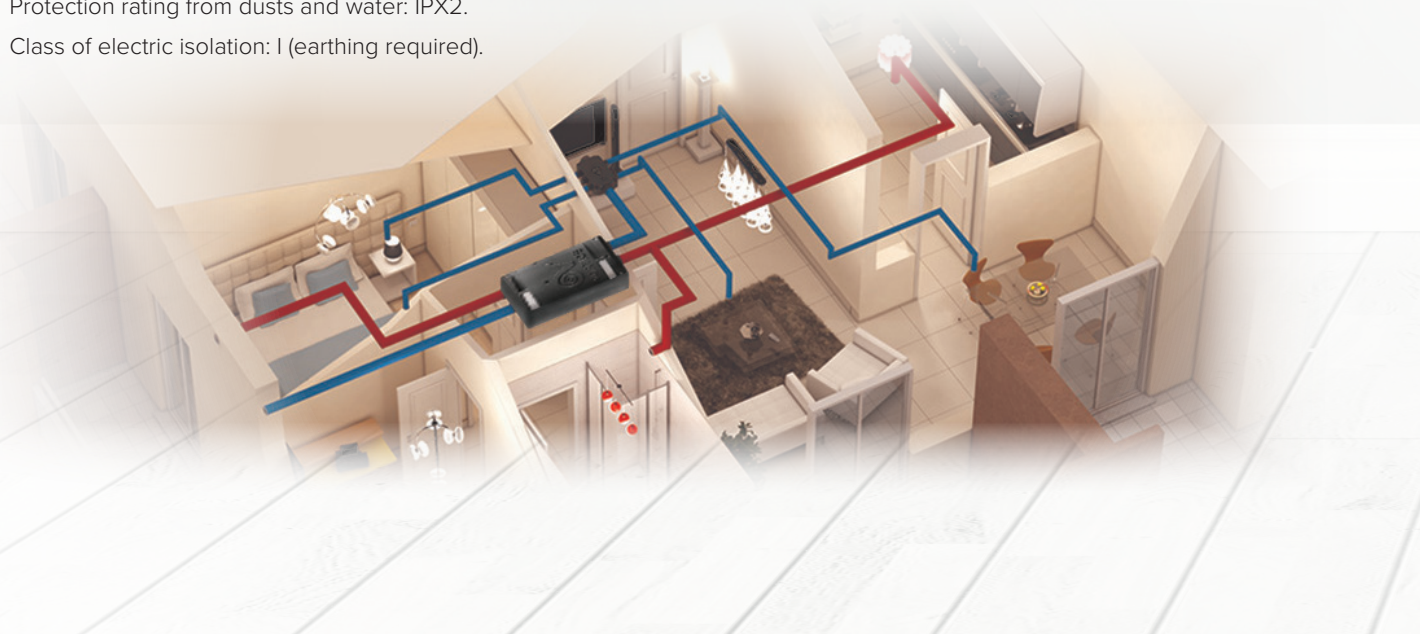





## KEY FEATURES

---

- Reduced thickness, suitable for installation in false-ceilings.
- 100% filtered by-pass, for natural ventilation (free-cooling) on summer evenings, with automatic drive (BP models).
- Wired remote control unit with LCD as per standard.



# VORT HRI PHANTOM RANGE

Ceiling-mounted heat recovery systems

## TECHNICAL DATA

MODELS	CODE	V ~ 50 Hz	W <sub>max</sub>	A <sub>max</sub>	MAX AIRFLOW		MAX PRESSURE		°C <sub>max</sub>	Kg
					m <sup>3</sup> /h	l/s	mmH <sub>2</sub> O	Pa		
VORT HRI 200 PHANTOM BP	11291	230	102	1.0	206	57,2	43.5	426	40	24
VORT HRI 350 PHANTOM BP	11293	230	165	1.4	350	97	58	568	50	33

## ENERGY DATA

	Unit of measurement	VORT HRI 200 PHANTOM	VORT HRI 350 PHANTOM
		11291	11293
Supplier's name or trade mark	-	Vortice	Vortice
Specific Energy Consumption class SEC in average climate zone	-	A	A
Specific Energy Consumption class SEC average		-36,3	-38
Specific Energy Consumption class SEC cold	kWh/m <sup>2</sup> year	-74,7	-77
Specific Energy Consumption class SEC warm		-11,7	-13
Declared typology	-	BRVU*	BRVU*
Type of drive	-	VSD**	VSD**
Type of heat recovery system HRS	-	recuperative	recuperative
Thermal efficiency of heat recovery at reference air flow	%	87,8	90,4
Maximum flow rate [m <sup>3</sup> /s]	m <sup>3</sup> /h	163	280
Electric power input of the fan drive, including any motor control equipment, at maximum flow rate	W	100	165
Sound power level LWA	LWA [dB(A)]	43	51
Reference flow rate	m <sup>3</sup> /s	0,0317	0,0544
Reference pressure difference	Pa	50	70
SPI***	W/(m <sup>3</sup> /h)	0,39474	0,35204
Control factor CTRL	-	0,85	0,85
Control typology	-	central demand control	central demand control
Maximum internal leakage rates	%	8,5	8,7
Maximum external leakage rates	%	8,5	5,2
Mixing rate	-	NA	NA
Position and description of visual filter warning	-	see user manual	see user manual
Airflow sensitivity to pressure variations at + 20Pa and - 20 Pa	-	NA	NA
Indoor/outdoor air tightness	m <sup>3</sup> /h	NA	NA
Annual electricity consumption (AEC)	kWh electricity/year	402	364
AHS average Annual heating saved		4570	4641
AHS cold Annual heating saved	kWh primary energy/year	8940	9078
AHS warm Annual heating saved		2067	2098

Energy data pursuant to 1254/2014 EU Regulation

\*BRVU: Bidirectional Residential Ventilation Unit  
 \*URVU: Unidirectional Residential Ventilation Unit

\*\*VSD: Variable Speed Drive  
 \*\*MSD: Multi Speed Drive

\*\*\*SPI: Specific Power Input

NA: data not applicable

## DIMENSIONS

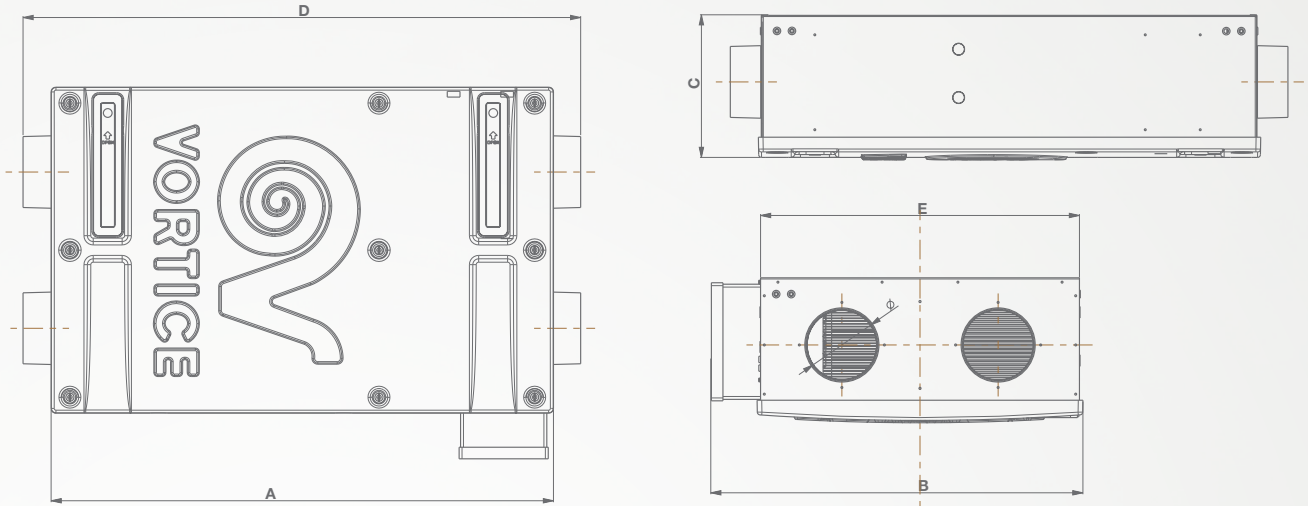

MODELS	CODE	A	B	C	D	E	Ø
VORT HRI 200 PHANTOM	11291	868	643	240	963.5	551	125
VORT HRI 350 PHANTOM	11293	1183	740	288	1287	650	150

Dimensions (mm)

## SOUND LEVELS

Sound power								Sound power Tot.	Pressure power Tot.		
Lw dB (A)								Lw dB (A)	Lp dB (A)*		
		125 Hz	250 Hz	500 Hz	1000 Hz	2000 Hz	4000 Hz	8000 Hz			
VORT HRI 200 PHANTOM											
Nom. speed	Supply to internal	22.7	31.4	17.4	14.9	10.1	n.a.**	n.a.**	43.3	22.8	
	Extract to internal	24.2	36.8	23	15.4	14.0	7.3	n.a.**	36.5	16.0	
	Breakout	35.7	36.9	29.2	22.2	17.0	9.8	n.a.**	43.1	22.6	
VORT HRI 350 PHANTOM											
Lw dB (A)								Lw dB (A)	Lp dB (A)*		
Nom. speed	Supply to internal	16.7	27.4	24.3	17.1	16.9	7.1	n.a.	37.2	16.7	
	Extract to internal	16.3	32.1	22.2	11.3	15.5	6.2	n.a.	37.8	17.3	
	Breakout	33.4	35.6	41.6	38.0	37.2	30.4	27.3	51.0	30.5	

Tests carried out according EN9614 standard, product featuring 270 m<sup>3</sup>/h at 110 Pa.

\*Sound pressure calculated at 3 m distance in free-field.

n.a. = data not available.



# VORT HRI PHANTOM RANGE

Ceiling-mounted heat recovery systems

## PERFORMANCE CURVES

VORT HRI 200 PHANTOM

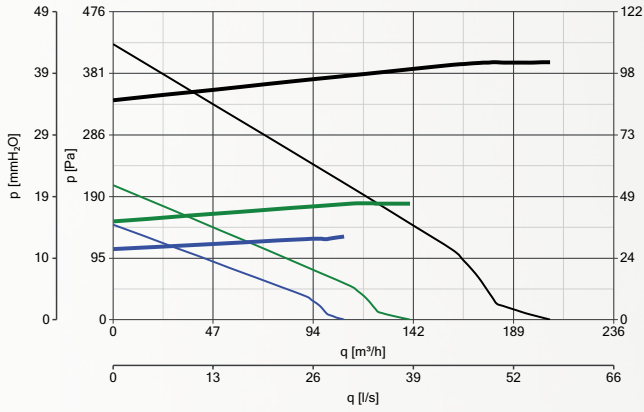

VORT HRI 350 PHANTOM

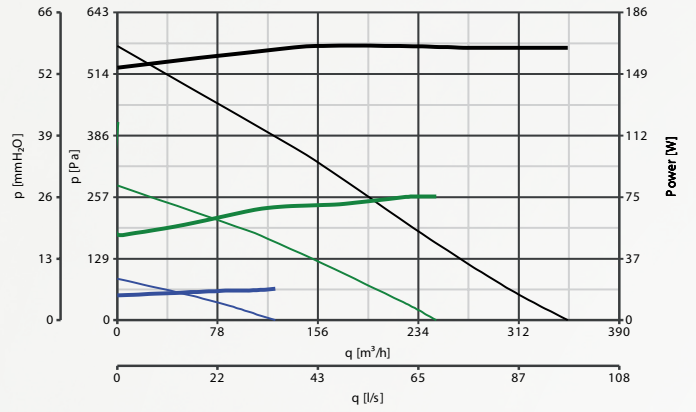

Efficiency as a function of the airflow

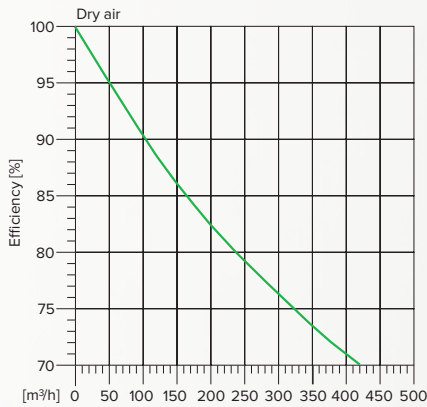

Efficiency as a function of the airflow

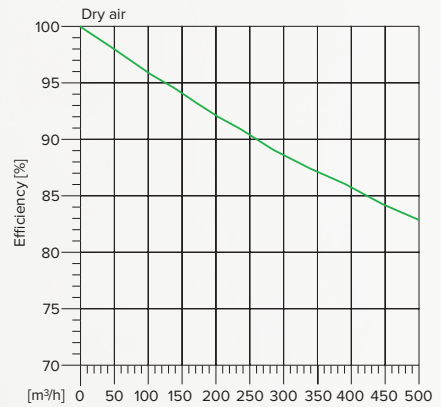

Influence on efficiency due to condensation heat

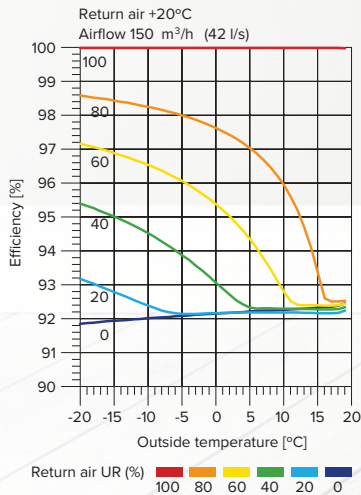

Influence on efficiency due to condensation heat

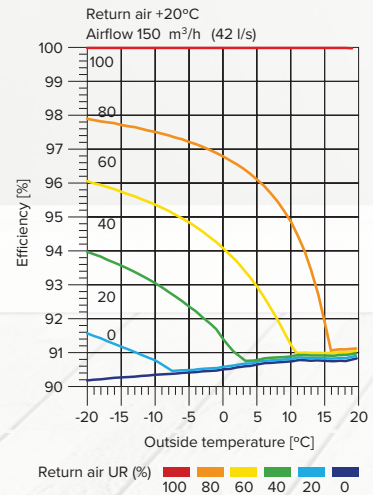

**ACCESSORIES**



F7 Internal filter - code 22625 only for code 11291



F7 Internal filter - code 22628 only for code 11293



SKP10 - code 22629 Control panel



Electric heater - code 22734 only for code 11291



Electric heater - code 22735 only for code 11293



NRG DCW (Water battery for HRI PHANTOM) - code 24146 for all models

VKC619 - code 46313 Circular adapter 150-125



NA 125 - code 22781 Noise attenuator



NA 150 - code 22756 Noise attenuator



Flexible Silencer diam. 125 - code 22366



Flexible Silencer diam. 150 (500 mm) - code 22316

**CONTROLS**



C PIR - code 12998 Motion sensor

**LCD CONTROL PANEL FULL VERSIONS**

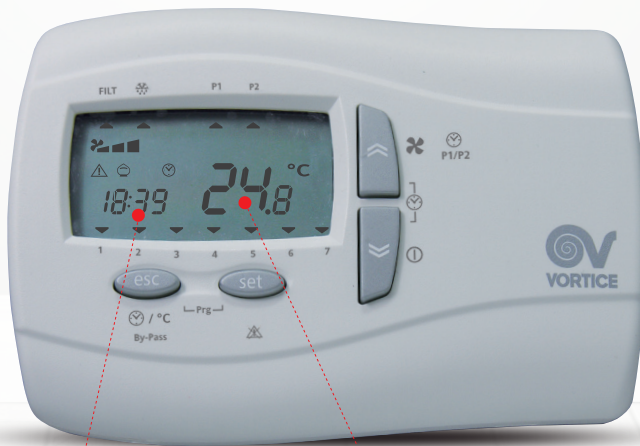

TIMER

TEMPERATURE

- To switch the machine on/off.
- To select one of the 3 speed settings.
- Selecting the By-pass function.
- Programmable timetable setting.
- Set point environmental temperature.
- Warnings display.
- Time or external temperature display.

**Icons**

- 
- P1 - P2**
- 
- 
- 
- 
- 
- FILT**
- HA**

**Functions**

- No-Frost
- Programs profile
- Speeds
- OFF
- Allarms
- By-pass
- Time/Programmable timetable
- Filter warning
- Antibacterial function



# VORT HRI INVISIBLE-E RANGE

Ceiling-mounted heat recovery units

## A

Dual flow, false-ceiling, very high efficiency centralised ventilation unit with heat recovery. Ideal for ventilation of homes and residential and commercial premises measuring up to 120 m<sup>2</sup> (HRI E ONE F), or 240 m<sup>2</sup> (HRI E TWO F), characterised by high levels of heat insulation.

- 4 models, different regarding dimensions and performance, equipped with thermodynamic and mechanical by-pass.
- Fire-resistant (DIN EN 13501) expanded polypropylene casing (PPE) with zinc-coated side plates. Tie-rods for suspended installation included in standard supply.
- Extraction and delivery spigots compatible with pipes having nominal diameter equal to 125 mm (HRI E ONE) and 125 mm (HRI E TWO).
- Pair of electric fans driven by external rotor EC motors (brushless) with shafts mounted on ball bearings, directly coupled to backward-curved centrifugal impellers for high aerodynamic efficiency. 3 operating speeds, can be set independently on installation
- High efficiency counter cross flow heat exchanger, made in plastic resin (PS).
- Automatically activated anti-freeze protection to prevent the formation of frost at the heat exchanger.
- Thermodynamic or mechanical by-pass (BP models), automatic and 100% filtered to guarantee the comfort of the occupants of the rooms in mid-season, or however when the outdoor temperature does not require the action of the heat exchanger.
- Wired remote control unit with LCD supplied as per standard, which allows:
  - product switch-on and switch-off;
  - the initial configuration of the product;
  - the choice of minimum, medium or maximum operating speed;
  - programming operation;
  - display of the time and room temperature,
  - monitoring of the correct operation of the product (any malfunctioning is highlighted through error messages shown on the display);
  - indication of the condition of the saturated filters on the display.
- Pair of M5 filters (F7 filter available as an optional for the delivery duct), easily accessible for periodic maintenance interventions.
- Condensate collection tray with drain devices.
- Possibility of interlocking (F models) to outdoor environmental sensors (optionals) for automatic control of the operating mode.
- Safety certified by third party body (CE).
- Protection rating from dusts and water: IPX2.
- Class of electric isolation: I (earthing required)

## HRI-E ONE F

- 3 speeds selectable manually.
- 100% manually operated, filtered by-pass.

## HRI-E TWO F

- Wired control panel with LCD display.
- 100% automatic and filtered by-pass.
- Compatible with BM5 (ModBus protocol on RS485 in slave mode).
- Compatible with wired Vortice environmental sensors.



## KEY FEATURES

---

- Reduced thickness, suitable for installation in false-ceilings.
- Brushless motors that provides very low electric consumption and reduced noise emissions.
- 100% filtered by-pass, for natural ventilation (free-cooling) on summer evenings, with automatic drive (Full models).
- Wired remote control unit with LCD as per standard.



# VORT HRI INVISIBLE-E RANGE

Ceiling-mounted heat recovery units

## TECHNICAL DATA

MODELS	CODE	V ~ 50 Hz	W max	A max	MAX AIRFLOW		MAX PRESSURE		°C max	Kg
					m³/h	l/s	mmH <sub>2</sub> O	Pa		
HRI-E ONE F	11218	230	71	0,55	187	52	52	232	45	17,5
HRI-E TWO F	11228	230	167	1,4	365	101	101	758	45	29,5

## ENERGY DATA

	Code	Unit of measurement	HRI-E ONE HRI-E ONE F	HRI-E TWO HRI-E TWO F
			11218	11228
Supplier's name or trade mark	-	-	-38,0	-38,8
Specific Energy Consumption class SEC in average climate zone	-	-	-76,8	-77,1
Specific Energy Consumption class SEC average	-	-	-13,1	-14,3
Specific Energy Consumption class SEC cold	-	kWh/m² year	BRVU*	BRVU*
Specific Energy Consumption class SEC warm	-	-	VSD**	VSD**
Declared typology	-	-	recuperative	recuperative
Type of drive	-	-	89,8	87,5
Type of heat recovery system HRS	-	-	134	335
Thermal efficiency of heat recovery at reference air flow	-	%	65,5	170,0
Maximum flow rate [m³/s]	-	m³/h	56	69
Electric power input of the fan drive, including any motor control equipment, at maximum flow rate	-	W	0,0261	0,0651
Sound power level LWA	-	LWA [dB(A)]	50	370
Reference flow rate	-	m³/s	0,34648	0,28145
Reference pressure difference	-	Pa	0,85	0,85
SPI***	-	W/(m³/h)	central demand control	central demand control
Control factor CTRL	-	-	<1	6,7
Control typology	-	-	3,9	2,5
Maximum internal leakage rates	-	%	NA	NA
Maximum external leakage rates	-	%	NA	NA
Mixing rate	-	-	NA	NA
Position and description of visual filter warning	-	-	NA	NA
Airflow sensitivity to pressure variations at + 20Pa and – 20 Pa	-	-	359	300
Indoor/outdoor air tightness	-	m³/h	4624	4562
Annual electricity consumption (AEC)	-	kWh electricity/year	9046	8924
AHS average Annual heating saved	-	-	2091	2063
AHS cold Annual heating saved	-	kWh primary energy/year	8940	9078
AHS warm Annual heating saved	-	-	2067	2098

\*BRVU: Bidirectional Residential Ventilation Unit  
 \*URVU: Unidirectional Residential Ventilation Unit

\*\*VSD: Variable Speed Drive  
 \*\*MSD: Multi Speed Drive

\*\*\*SPI: Specific Power Input

NA: data not applicable



**DIMENSIONS**

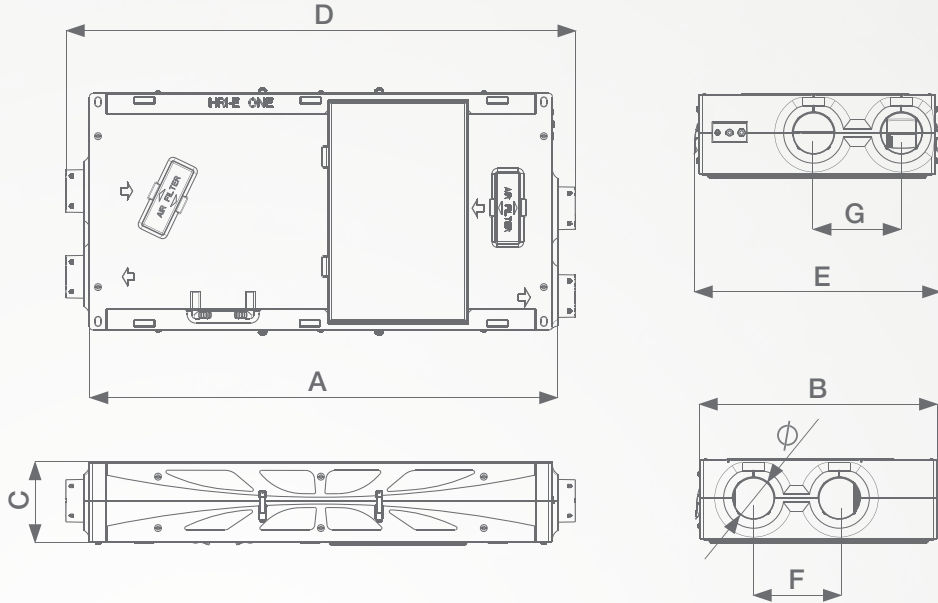

MODELS	CODE	A	B	C	D	E	F	G	Ø
HRI-E ONE F	11218	1350	690	244	1485	720	250	256	123

Dimensions (mm)

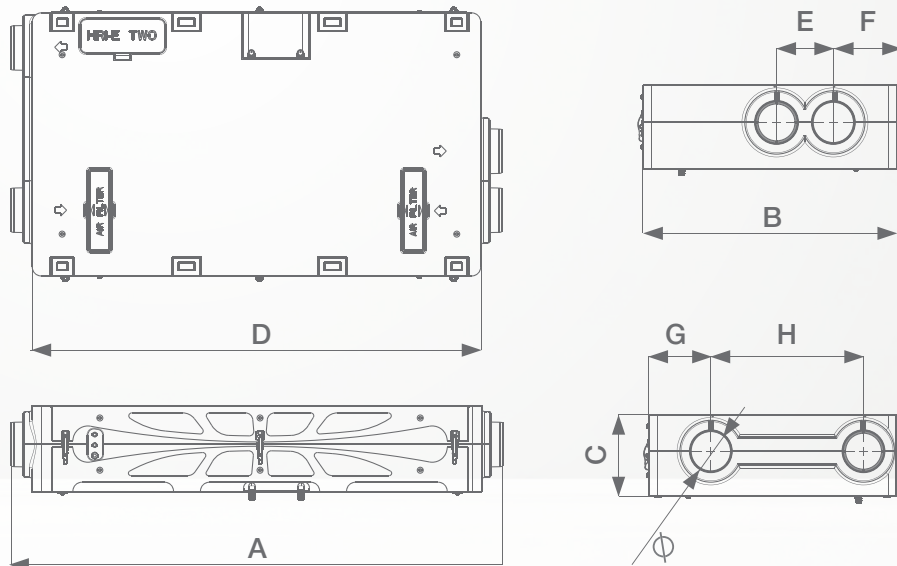

MODELS	CODE	A	B	C	D	E	F	G	H	Ø
HRI-E TWO F	11228	1640	916	290	1500	197	238	238	543	149

Dimensions (mm)



# VORT HRI INVISIBLE-E RANGE

Ceiling-mounted heat recovery units

## SOUND LEVELS

VORT HRI-E ONE F		Sound power							Sound power Tot.	Pressure power Tot.
		Lw dB (A)								
		125 Hz	250 Hz	500 Hz	1000 Hz	2000 Hz	4000 Hz	8000 Hz		
Min. Speed	Supply to internal	3.1	14.7	17.4	20.5	2.7	7.2	24.2	27.3	6.8
	Extract to internal	7.3	17.6	20.4	27.6	14.6	0.4	14.1	33.4	12.9
	Breakout	11.4	21.9	31.4	32.4	19.2	9.3	4	39.1	18.6
Med. Speed	Supply to internal	13.7	23.9	25.8	31.2	14.8	7.5	9	37	16.5
	Extract to internal	15.3	23	25.6	35.5	23	12.8	3	40.2	19.7
	Breakout	19.7	28.9	36.7	42.4	30.5	25.4	15.5	48.1	27.6
Max. Speed	Supply to internal	22.3	30.7	32.1	36.5	23.7	16.7	3.9	43.7	23.2
	Extract to internal	22.5	29.9	32.9	40.9	31.1	21.1	9.3	46.8	26.3
	Breakout	23.4	35.7	50.9	46.9	38.5	33.9	25.7	55.5	35.2

Tests carried out according to EN 9614 standard.\*\*Sound pressure calculated at 3 m distance in free-field.

VORT HRI-E TWO F		Sound power							Sound power Tot.	Pressure power Tot.
		Lw dB (A)								
		125 Hz	250 Hz	500 Hz	1000 Hz	2000 Hz	4000 Hz	8000 Hz		
Min. Speed	Supply to internal	23.7	32	37.6	34.8	28.9	20	15.2	47.5	26.96
	Extract to internal	17.1	24.7	23.5	16.3	15.2	13.6	14.9	31.8	11.26
	Breakout	23.8	32.5	39.4	33.1	27.4	18.2	17.7	45.5	24.96
Med. Speed	Supply to internal	31.3	52.4	54	53.4	48.4	43.2	29.2	64.7	44.16
	Extract to internal	16.7	39.2	35.3	28.5	24.7	16	15.4	45.7	25.16
	Breakout	36.1	48.7	51.1	46.8	43.6	35.3	22	58.2	37.66
Max. Speed	Supply to internal	39.2	53.4	64	63.2	59.8	55.6	43.9	78.3	57.76
	Extract to internal	24.1	41.7	44.3	34.6	35.2	23.6	15.2	54.7	24.16
	Breakout	42.5	51.3	60.2	55.5	53.9	47.2	33.2	69.3	48.76

Tests carried out according to EN 9614 standard.\*\*Sound pressure calculated at 3 m distance in free-field.

PERFORMANCE CURVES

HRI-E ONE F EFFICIENCY

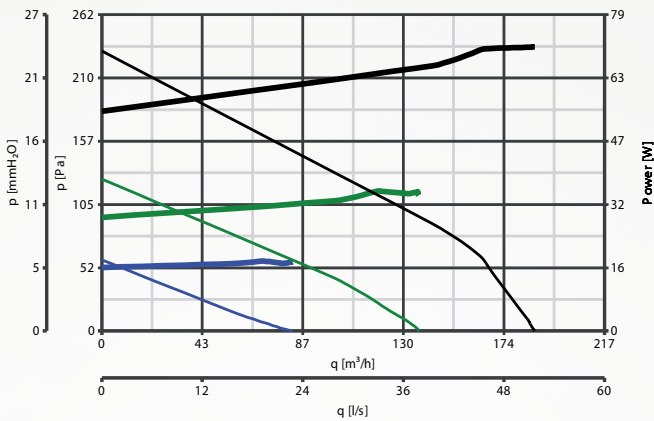

- Power consumption
  - Max - max
  - Min - max
  - Min - min
- Performance curves
  - Max - max
  - Min - max
  - Min - min

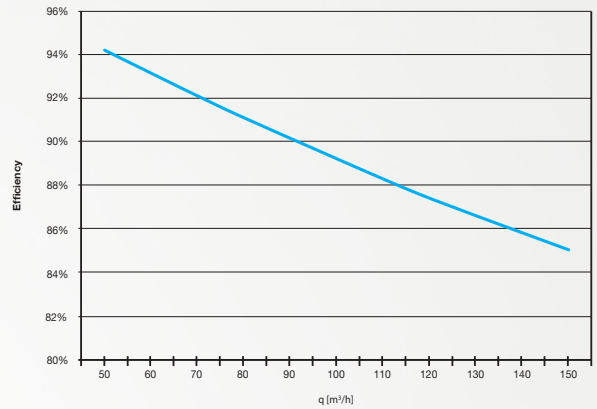

Test conditions according to EN 308: +5°C/70%; +25°C/28%.

Efficiency as a function of the airflow

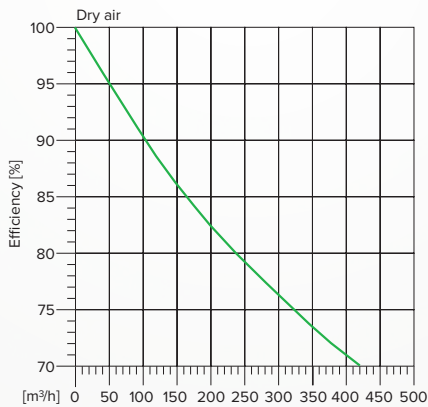

Influence on efficiency due to condensation heat

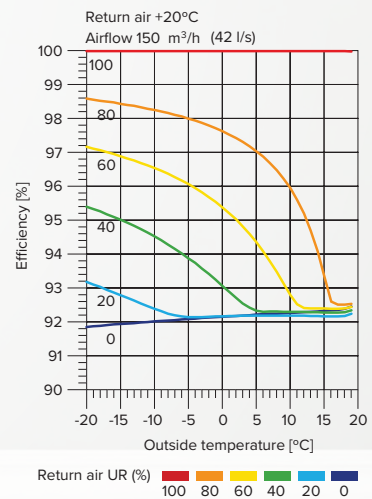



# VORT HRI INVISIBLE-E RANGE

Ceiling-mounted heat recovery units

## PERFORMANCE CURVES

### HRI-E TWO F EFFICIENCY

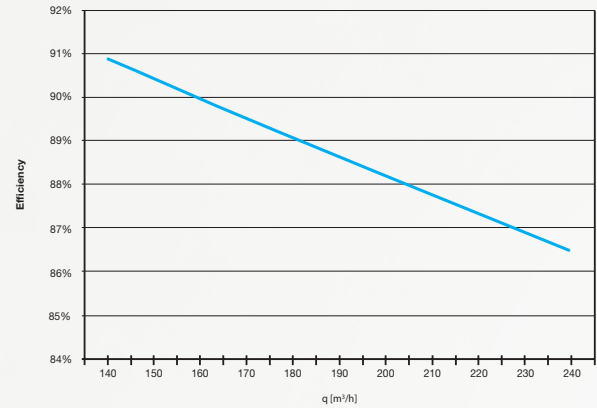
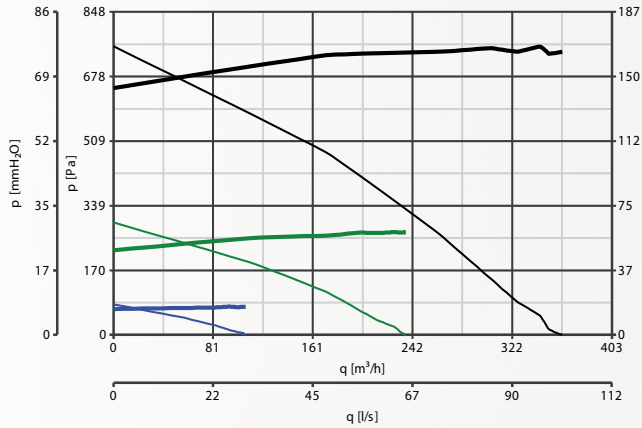

Test conditions according to EN 308: +5°C/70%; +25°C/28%.

Power consumption  
 — Max - max  
 — Min - max  
 — Min - min

Performance curves  
 — Max - max  
 — Min - max  
 — Min - min

### Efficiency as a function of the airflow

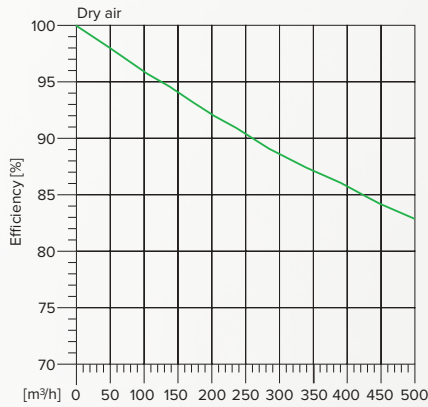

### Influence on efficiency due to condensation heat

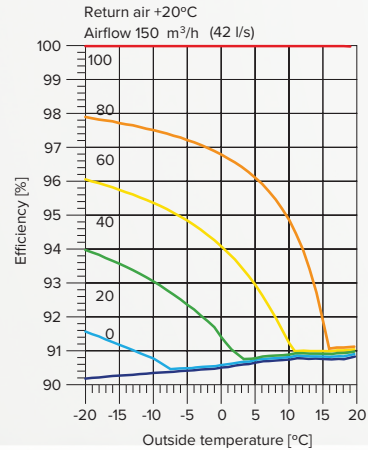

Return air UR (%)  
 100 80 60 40 20 0

**ACCESSORIES**



Pre-heating box HRI-E TWO (750 W) - code 22627 only for code 11228



F7 Filter - code 22628 only for code 11228



SKP10 - code 22629 Control panel for all models

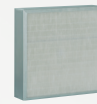

F5 filter HRI-ONE - code 22645 only for codes 11218

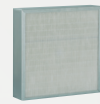

F7 internal filter - code 22549 only for codes 112218



Brackets kit - code 22548 only for codes 11218



Brackets kit - code 22648 only for codes 11228



Pre-heating box for HRI-E ONE (500 W) - code 22598 only for code 11218

**CONTROLS**



C PIR - code 12998 Motion sensor

**LCD CONTROL PANEL FULL VERSIONS**

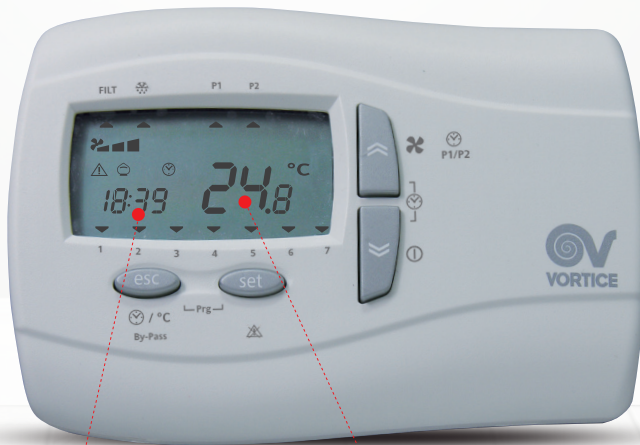

TIMER

TEMPERATURE

- To switch the machine on/off.
- To select one of the 3 speed settings.
- Selecting the By-pass function.
- Programmable timetable setting.
- Set point environmental temperature.
- Warnings display.
- Time or external temperature display.

**Icons**

**Functions**

	No-Frost
<b>P1 - P2</b>	Programs profile
	Speeds
	OFF
	Allarms
	By-pass
	Time/Programmable timetable
<b>FILT</b>	Filter warning
<b>HA</b>	Antibacterial function



# VORT HA SYSTEM

Heat recovery system for false ceiling installation with antibacterial filter

A

The HA PHANTOM SYSTEM is a controlled mechanical double flow ventilation system able to integrate normal ventilation using outside air with an antibacterial treatment.

The HA system (Heat recovery with Antibacteria) consists of two elements: a VORT HRI PHANTOM which is combined with a filtering unit with antibacterial treatment. When it is switched on, special shutters block the outward airflow and divert it directly to a special antibacterial filter treated with a solution of Chitosan and Titanium Dioxide. Low-voltage UV lamps emit radiation at 415 nm thus activating photocatalysis, an active substance that inhibits the growth of bacteria, killing it, and returning effectively purified air. A flap on the outside of the module facilitates replacement of the filter that can be safely removed because it contains no active bacteria. The air purification cycle involves alternating between air exchange with heat recovery and antibacterial filtering. This cycle can be activated automatically by a pre-set program or manually by users according to their specific needs. It is a good idea to choose the filtering function at off-peak times, such as in a private home in the daytime when the occupants are at work or at school so that they can come home to a healthy, comfortable environment.

## VORT HA system operation

VORT HA operation alternates between Fan and Purification modes according to the actual needs of the people in the rooms: when there are occupants (in the case of a home in the early hours of the morning, at lunch, in the evening and for most of the night), VORT HA ventilates as a traditional heat recovery unit, expelling the stale air outside and replacing it with fresh air, suitably pre-heated or pre-cooled (winter or summer), and filtered.

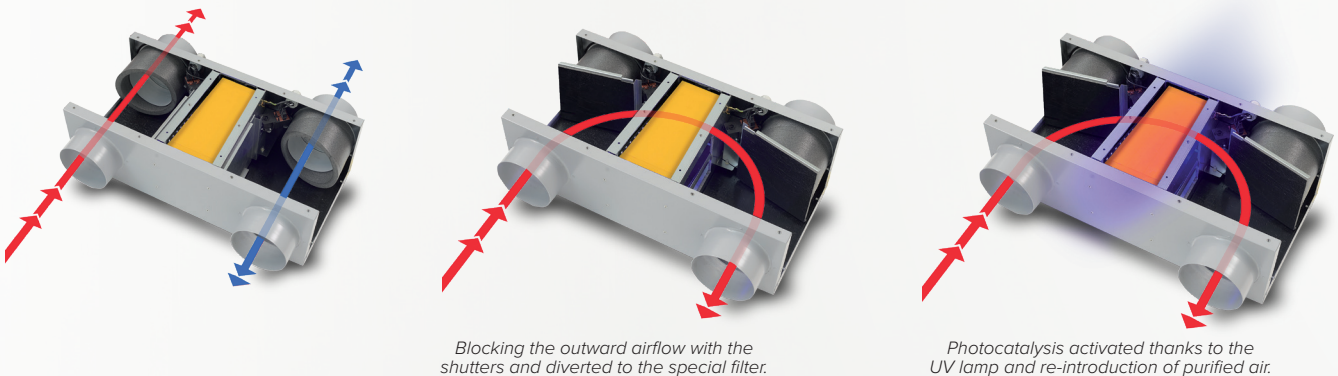

At times when rooms are not occupied, fresh air intake stops and the room's air is purified. This air is forced to recycle in the air cleaner to maximize the efficiency of the relevant filter. Specifically, the action of the heat recovery filters, which retain most of the fine dust suspended in the air, is combined with the external, patented, air cleaner, which reduces bacterial load and prevents this load from proliferating, furthering lowering the concentration of fine dust produced by previous actions or introduced by people occupying the space. This allows the high standards of air quality, optimal for health and comfort, to be reached.

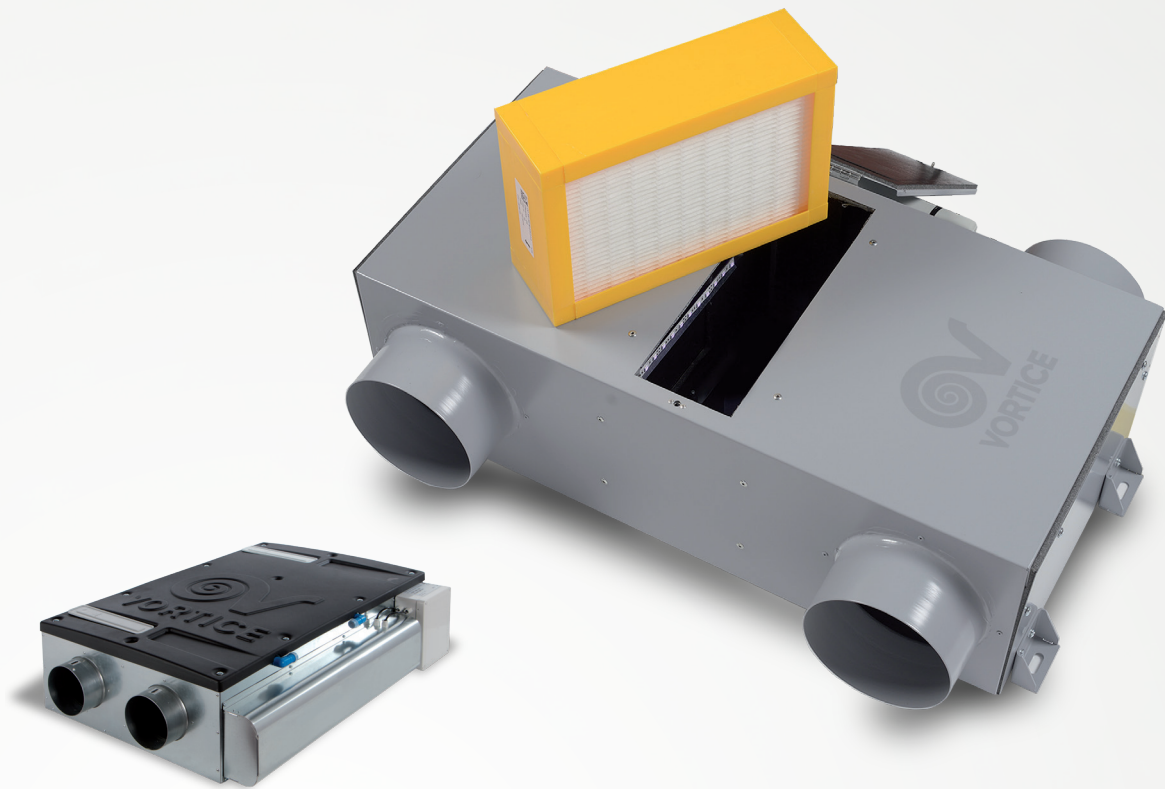

## KEY FEATURES

- Effective: it ensures that the levels of temperature, relative humidity and air purity required for prevention of discomfort and illness are maintained.
- Economical: the highly efficient heat exchange and low levels of consumption ensure optimum use of the heating and cooling systems, keeping operating costs down.
- Noiseless: low noise emissions ensure that the system will not disturb you at night, meaning that the system can be used continuously.
- Tested: tests conducted by the Polytechnic of Milan confirm the efficiency of the VORT HA.

## TECHNICAL DATA

MODELS	CODE	MODEL	V ~ 50 Hz	W <sub>max</sub>	A <sub>max</sub>	MAX AIRFLOW		MAX PRESSURE		Kg
						m <sup>3</sup> /h	l/s	mmH <sub>2</sub> O	Pa	
HA PHANTOM 200	11448	11291	230	102	1.0	206	57,2	43.5	426	34
HA PHANTOM 350	11449	11293	230	165	1,4	350	97	58	568	44



# VORT HRI FLAT RANGE

Ceiling-mounted heat recovery systems

## A

Centralized double flow ventilation unit with heat recovery unit for false-ceiling installation. The ideal compromise between performance, functions, purchase and operating costs makes the VORT HRI FLAT range the most cost-effective solution for the ventilation of residential and commercial premises up to 90 m<sup>2</sup> (VORT HRI 200 FLAT) or 240 m<sup>2</sup> (VORT HRI 350 FLAT), characterised by high levels of heat insulation.

- Galvanized sheet steel enclosure, fully clad with sound-absorbing, fire-resistant material (DIN EN 13501).
- Fittings connection ports with a nominal diameter of 125 mm or 150 mm depending on the model.
- Ultra high-efficiency crossed counter-flow type heat exchanger in PS resin.
- High-efficiency fans equipped with centrifugal impellers with backward-curved blades driven by EC motors (brushless) with 3 speeds.
- Automatic thermo-dynamic by-pass
- 2xM5 filters (optional F7 filter for the air intake duct), which are easily accessible for maintenance purposes.
- Integrated frost protection
- Remote control unit, for inline connection, for:
  - Switching on and off
  - Selecting the operating speed from the 3 available settings.
  - Signaling, via LED, of filter clogged status (the duration of the time frequency between two cleaning/filter replacement operations, depending on the appliance operating speed, can be set at the time of installation).
- Tie-rods for suspended installation.
- Water protection rate IPX2.
- Insulation class: I ⊕.



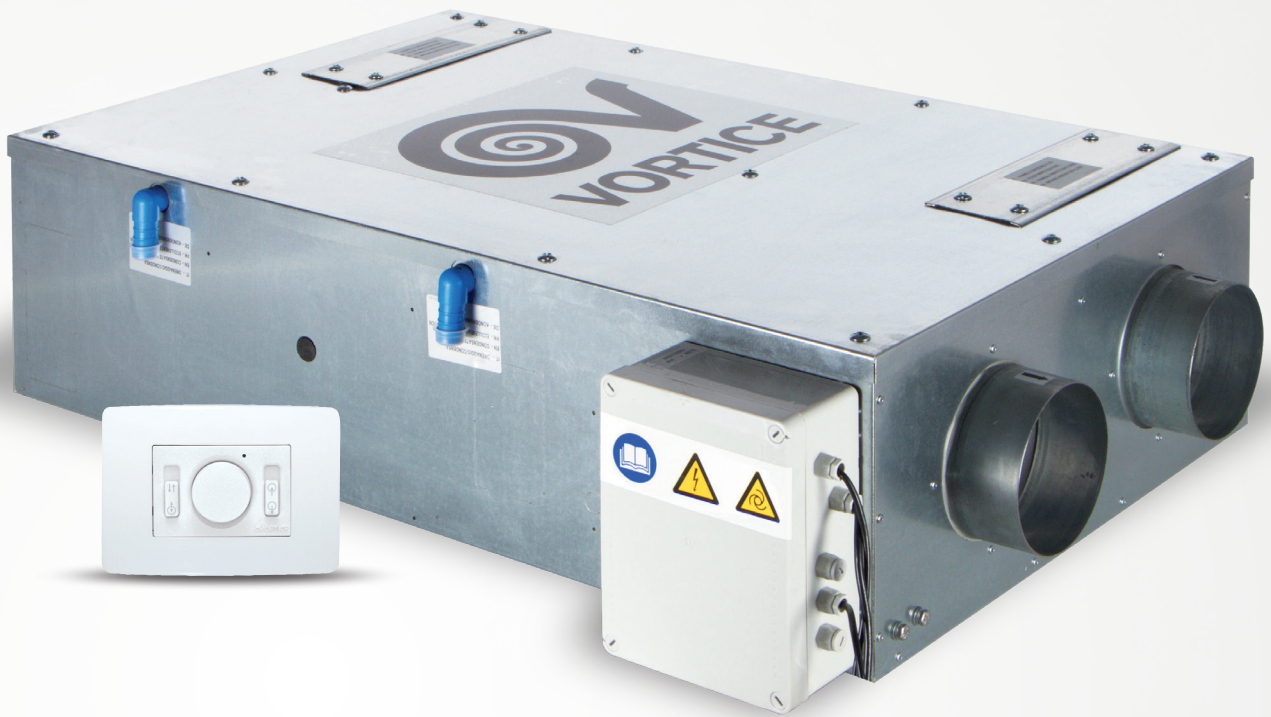

## KEY FEATURES

- Excellent compromise between high output, reduced purchase price and limited operating costs.
- Compact overall size; specifically, the limited thickness makes it fit for installation in false ceilings, which is useful when there are no dedicated technical premises.
- Sturdy and concurrently light-weight construction, which makes handling and installation easy.
- High efficiency, compliant with the most recent ErP regulations (Reg. No. 327/2011/EU, 1253/2014/EU, 1254/2014/EU).
- Superior (up to 92%) heat exchange efficiency levels in the conditions (+5°C, 50%RH/25°C, 28%RH) set by the applicable international regulations (EN 308).
- Simplified extraordinary maintenance thanks to rational internal layout of the main components, easily accessible once the product is installed.



# VORT HRI FLAT RANGE

Ceiling-mounted heat recovery systems

## TECHNICAL DATA

MODELS	CODE	V ~ 50 Hz	W max	A max	MAX AIRFLOW		MAX PRESSURE		°C max	Kg
					m <sup>3</sup> /h	l/s	mmH <sub>2</sub> O	Pa		
VORT HRI 200 FLAT	11281	230	102	1.0	206	57,2	43.5	426	40	24
VORT HRI 350 FLAT	11282	230	250	2.0	380	105	56	550	50	33

## ENERGY DATA

	Code	Unit of measurement	VORT HRI 200 FLAT	VORT HRI 350 FLAT
			11281	11282
Supplier's name or trade mark	-	-	Vortice	Vortice
Specific Energy Consumption class SEC in average climate zone	-	-	A	A
Specific Energy Consumption class SEC average	-	-	-36,3	-38
Specific Energy Consumption class SEC cold	-	kWh/m <sup>2</sup> year	-74,7	-77
Specific Energy Consumption class SEC warm	-	-	-11,7	-13
Declared typology	-	-	BRVU*	BRVU*
Type of drive	-	-	VSD**	VSD**
Type of heat recovery system HRS	-	-	recuperative	recuperative
Thermal efficiency of heat recovery at reference air flow	-	%	87,8	90,4
Maximum flow rate [m <sup>3</sup> /s]	-	m <sup>3</sup> /h	163	280
Electric power input of the fan drive, including any motor control equipment, at maximum flow rate	-	W	100	165
Sound power level LWA	-	LWA [dB(A)]	43	51
Reference flow rate	-	m <sup>3</sup> /s	0,0317	0,0544
Reference pressure difference	-	Pa	50	70
SPI***	-	W/(m <sup>3</sup> /h)	0,39474	0,35204
Control factor CTRL	-	-	0,85	0,85
Control typology	-	-	central demand control	central demand control
Maximum internal leakage rates	-	%	8,5	8,7
Maximum external leakage rates	-	%	8,5	5,2
Mixing rate	-	-	NA	NA
Position and description of visual filter warning	-	-	see user manual	see user manual
Airflow sensitivity to pressure variations at + 20Pa and - 20 Pa	-	-	NA	NA
Indoor/outdoor air tightness	-	m <sup>3</sup> /h	NA	NA
Annual electricity consumption (AEC)	-	kWh electricity/year	402	364
AHS average Annual heating saved	-	-	4570	4641
AHS cold Annual heating saved	-	kWh primary energy/year	8940	9078
AHS warm Annual heating saved	-	-	2067	2098

\*BRVU: Bidirectional Residential Ventilation Unit  
\*URVU: Unidirectional Residential Ventilation Unit

\*\*VSD: Variable Speed Drive  
\*\*MSD: Multi Speed Drive

\*\*\*SPI: Specific Power Input

NA: data not applicable

**DIMENSIONS**

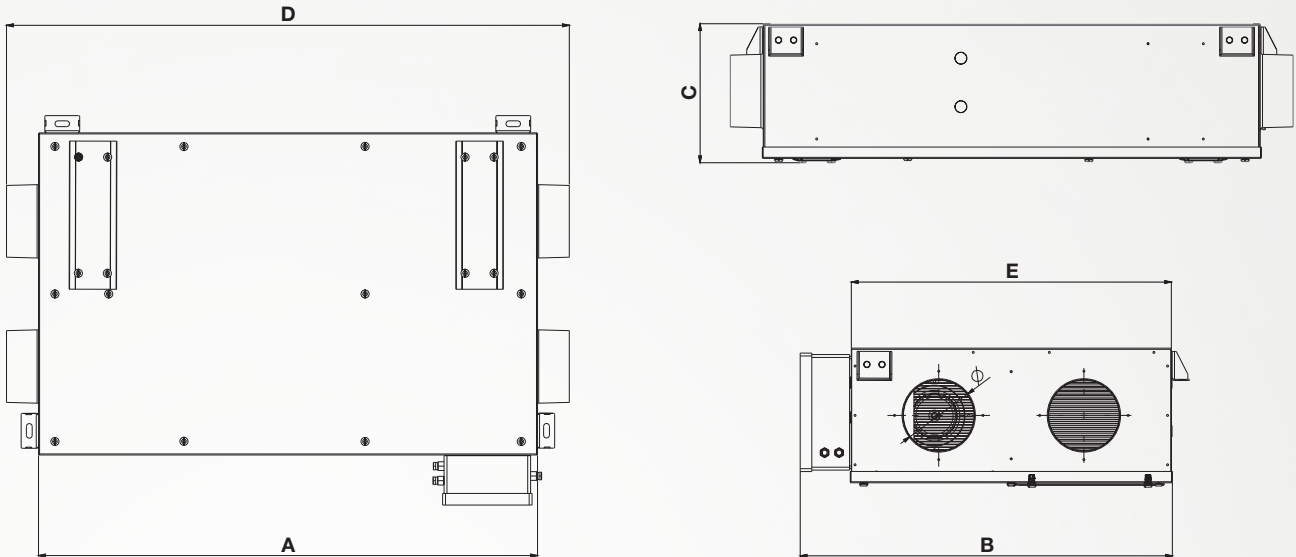

MODELS	CODE	A	B	C	D	E	Ø
VORT HRI 200 FLAT	11281	860	643	240	969	551	125
VORT HRI 350 FLAT	11282	1183	740	288	1287	650	150

Dimensions (mm)

**SOUND LEVELS**

		Sound power							Sound power Tot.	Pressure power Tot.
		Lw dB (A)							Lw dB (A)	Lp dB (A)*
		125 Hz	250 Hz	500 Hz	1000 Hz	2000 Hz	4000 Hz	8000 Hz		
VORT HRI 200 FLAT	Supply to internal	22.7	31.4	17.4	14.9	10.1	n.a.**	n.a.**	43.3	22.8
	Extract to internal	24.2	36.8	23	15.4	14.0	7.3	n.a.**	36.5	16.0
	Breakout	35.7	36.9	29.2	22.2	17.0	9.8	n.a.**	43.1	22.6
		Sound power							Sound power Tot.	Pressure power Tot.
		Lw dB (A)							Lw dB (A)	Lp dB (A)*
		125 Hz	250 Hz	500 Hz	1000 Hz	2000 Hz	4000 Hz	8000 Hz		
VORT HRI 350 FLAT	Supply to internal	16.7	27.4	24.3	17.1	16.9	7.1	n.a.	37.2	16.7
	Extract to internal	16.3	32.1	22.2	11.3	15.5	6.2	n.a.	37.8	17.3
	Breakout	33.4	35.6	41.6	38.0	37.2	30.4	27.3	51.0	30.5

Tests carried out according EN9614 standard, product featuring 270 m³/h at 110 Pa.

\*Sound pressure calculated at 3 m distance in free-field.

n.a. = data not available.



# VORT HRI FLAT RANGE

Ceiling-mounted heat recovery systems

## PERFORMANCE CURVES

VORT HRI 200 FLAT

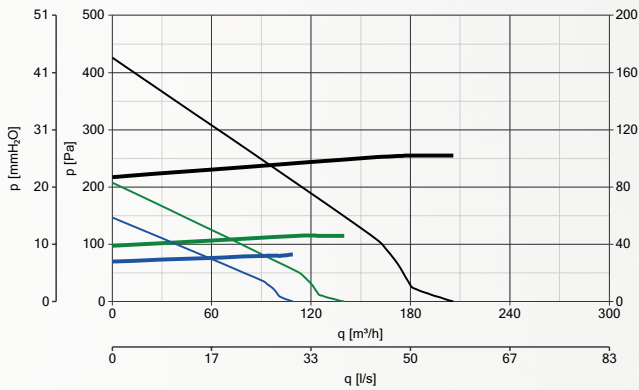

VORT HRI 350 FLAT

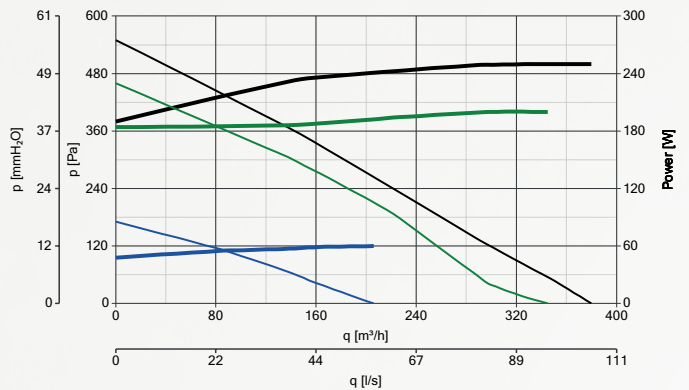

Efficiency as a function of the airflow

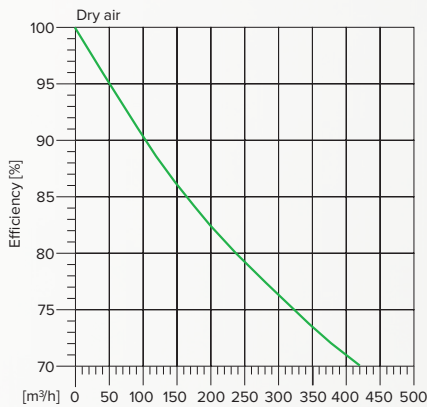

Efficiency as a function of the airflow



Power consumption  
 — Max - max  
 — Min - max  
 — Min - min

Performance curves  
 — Max - max  
 — Min - max  
 — Min - min

Influence on efficiency due to condensation heat

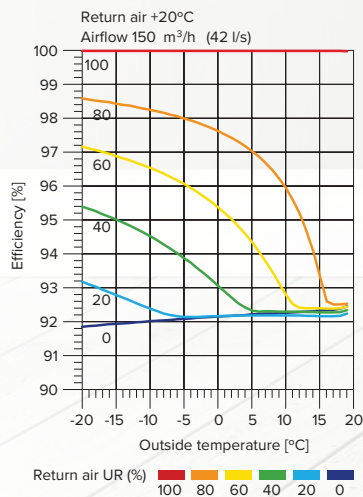

Influence on efficiency due to condensation heat

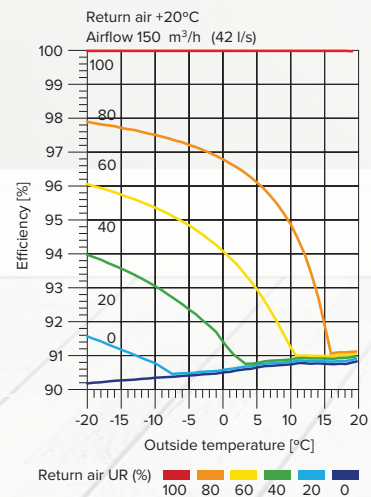

**ACCESSORIES**

---



Electric heater 750 W - code 22734  
for VORT HRI 200 FLAT (11281)



Electric Heater 750 W -code 22735  
for VORT HRI 350 FLAT (11282)

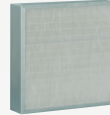

F7 Internal filter - code 22625  
Filter for HRI-ONE

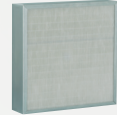

F7 Internal filter - code 22628  
Filter for HRI-TWO

code 21431  
FILTER KIT 227x212x24 M5

code 21432  
FILTER KIT 227x212x24 F7



NOTE

Lined area for notes



Vortice Elettrosociali S.p.A  
Strada Cerca, 2  
Frazione di Zoate  
20067 Tribiano (Milano)  
Tel. (+39) 02 906991  
Fax (+39) 02 90699625  
Italia  
[www.vortice.com](http://www.vortice.com)

Vortice Limited  
Beeches House-Eastern  
Avenue Burton on Trent  
DE13 0BB  
Tel. (+44) 1283-49.29.49  
Fax (+44) 1283-54.41.21  
United Kingdom  
[www.vortice.ltd.uk](http://www.vortice.ltd.uk)

Vortice Ventilation System  
(ChangZhou) Co.LTD  
No. 388 West Huanghe Road  
Building 19, ChangXhou  
Post Code: 213000  
China  
Tel. (+86) 0519 88990150  
Fax (+86) 0519 88990151  
[www.vortice-china.com](http://www.vortice-china.com)

Vortice Latam S.A.  
3er Piso, Oficina 9-B  
Edificio Meridiano  
Guachipelín, Escazú  
San José, Costa Rica  
PO Box 10-1251  
Tel. (+506) 2201.6219  
Fax (+506) 2201.6239  
[www.vortice-latam.com](http://www.vortice-latam.com)

